

# OPERATING AND COMMISSIONING INSTRUCTIONS



# OPERATING AND COMMISSIONING INSTRUCTIONS

## Table des matières

I.	RECEIVING THE EQUIPMENT .....	4
I.1.	Checks on reception .....	4
I.2.	Unpacking.....	4
I.3.	Storing .....	4
I.4.	End of life .....	4
II.	INSTALLATION .....	5
II.1.	Handling .....	5
II.2.	Space required .....	5
II.1.	Installation.....	6
III.	GENERAL FONCTIONNING.....	7
III.1.	GENERAL.....	7
III.2.	ANALYSE FONCTIONNELLE .....	7
III.3.	REGULATION MODE .....	8
III.3.a.	SEASON :.....	8
III.3.b.	ECO :.....	8
III.3.c.	DIVA.....	8
III.3.d.	LOBBY® :.....	8
III.3.e.	MAC2® : (impossible with sizes 06-08) .....	8
III.3.f.	QUATTRO® : (impossible with sizes 06-08).....	9
III.4.	COMPOSITION .....	9
III.4.a.	SEASON.....	9
III.4.b.	ECO-DIVA-MAC2-QUATTRO .....	10
III.5.	ELEMENTS IN THE REGULATION .....	11
III.5.a.	REGULATION ECO/DIVA/LOBBY/MAC2/QUATTRO.....	11
IV.	ELECTRIC WIRING .....	11
IV.1.	POWER SUPPLY .....	11
IV.2.	CONTROL WIRING (SEASON).....	11
IV.2.a.	Remote alarm.....	12
IV.2.b.	External 0-10V (potentiometer) .....	12
IV.2.c.	Bypass.....	12
IV.2.a.	Automatic deicing .....	13
IV.3.	CONTROL WIRING (ECO/DIVA/LOBBY/MAC2/QUATTRO) .....	13
IV.3.a.	Temperature sensor.....	13
IV.3.b.	Terminal blocks.....	13
IV.4.	Electrical wiring and functioning of the plate exchanger .....	14
IV.5.	Automatic deicing .....	15
IV.6.	Filters pressure switches wiring and connection.....	15
IV.7.	Fan switches wiring and connection.....	15
IV.8.	Pressure transmitter LOBBY® MAC2® QUATTRO® wiring and connection .....	16
IV.9.	Motors wiring.....	16
IV.10.	CO2 transmitter wiring .....	16
IV.11.	Night Cooling.....	16
IV.12.	Hot water / cool water or changeover water coil .....	17
IV.13.	DX battery (cold or reversible).....	18
IV.14.	Electrical Battery.....	18
IV.15.	Deicing battery.....	19

# OPERATING AND COMMISSIONING INSTRUCTIONS

IV.16.	Fire function.....	19
IV.17.	Dehumidification function .....	19
IV.18.	MODBUS / WEB / BACNET wiring.....	20
IV.19.	Repeater wiring.....	20
IV.20.	LON.....	21
V.	SETTINGS .....	21
V.1.	Display (RJ9 4P4C) .....	21
V.2.	Exemple of setting.....	22
V.3.	Standard settings (opérateur menu) .....	22
V.3.a.	Running mode menu.....	23
V.3.b.	Temperature menu .....	24
V.3.c.	Ventilation menu.....	24
V.3.d.	Timer menu .....	25
V.4.	Operator parameters modification ( password 3333 required).....	26
V.4.a.	Dates and hours clocks setting.....	26
V.4.b.	Speed /pressure modification in LS and HS .....	26
V.4.c.	Temperature setpoint modification.....	27
V.4.d.	Forced stop of the unit or forced start LS or HS on the remote control .....	27
V.4.e.	Choice of language .....	27
V.5.	Intermediate settings (service level).....	27
V.5.a.	Menu configuration en accès service .....	28
V.6.	Modification of the services parameters (password 2222).....	28
V.6.a.	Regulation mode of the unit .....	28
V.6.b.	Overventilation parameters.....	28
V.6.c.	CO2 setpoint for DIVA / QUATTRO option.....	28
V.7.	Administrator settings.....	29
V.7.a.	Configuration menu with admin level access .....	29
V.8.	Modification of the service parameters .....	30
V.8.a.	MODBUS.....	30
V.8.b.	Repetitors and EXO communication .....	30
V.8.c.	WEB Communication .....	30
V.8.d.	BACNET IP Communication with BASC type .....	31
V.8.e.	Communication LON (si CORRIGO avec option LON) .....	31
V.8.f.	Fire function activation .....	31
V.8.g.	Activation of the function dehumidification.....	32
VI.	REPAIR .....	32
VI.1.	Différent type of defaults.....	32
VI.2.	List of alarms .....	32
VI.3.	Acknowledge the default « timer service » .....	34
VII.	MAINTENANCE .....	34
VII.1.	Obligatory maintenance .....	34
VII.2.	Battery replacement .....	35
VIII.	ANNEXES .....	36
VIII.1.	Control scheme.....	36
VIII.2.	Motor wiring SILVERTOP 06-08 .....	37
VIII.3.	Motor wiring SILVERTOP 15-52.....	38
VIII.4.	Curves .....	39
VIII.1.	Table MODBUS et BACNET .....	41

**OPERATING AND COMMISSIONING INSTRUCTIONS**IX. NOTES.....43**SAFETY INSTRUCTIONS**

In compliance with the current norms, the machine should be installed only by a technical person qualified for this type of work.

Use the required personal protection devices so as to avoid injuries caused by electrical and mechanical hazards (injuries by touching panels, sharp edges, etc.). Use EN170 protective eyewear and ear protection.

Do not use the unit for an other used which it designed. This unit can't be use for extract or supply dangerous air.

Move the machine as given in chapter *handling*.

Grounding is carried out in compliance with current standards. Never start the device without grounding

Before any intervention ensure that device is powered off and wait for complete stop of every rotative component such as damper, fan, rotative exchanger...

During device is running inspection doors must be mounted and closed.

Start is to be done only with padlockable swith.

Do not shut off or short circuit the safety and control equipment.

During interventions, be carefull with hot components such as hot water coil or electric resistances.

The machine should be installed in compliance with fire norms and regulation in each country.

The waste must be disposed of in compliance with the current standards. No packaging should be discarded into the environment.

We disclaim any responsibility for any damages resulting from wrong utilisation of the equipment, reparation, modification or non compliance of these instructions.

**I. RECEIVING THE EQUIPMENT**

Les centrales sont livrées fixées sur longerons ou sur plots puis emballés sous film plastique.

**I.1. Checks on reception**

When the equipment is received, the state of the packaging and the equipment must be checked. In the event of damage, make an accurate note of any problems on the carrier's delivery note

**I.2. Unpacking**

When the equipment is unpacked, check the following:

- The total number of packages is present.
- All accessories are present (dampers, roof, electric switchgear, etc.). After unpacking the equipment, the waste must be disposed of in compliance with the current standards. No packaging should be discarded into the environment

**I.3. Storing**

The equipment must be stored in shade, in a dry place, at a temperature between -20°C and 40°C. The packaging can't be considered sufficient for an external storage.

**I.4. End of life**

In accordance with the partnerships with the compagny ECOLOGIC. CALADAIR fulfills the obligations to finance the collection, removal and treatment of Waste Electrical and Electronic Equipment.

At the end of the life of this equipment, the user contacts the company ECOLOGIC who will propose a collection solution or a place of deposit for the product.

Contacts for pick-up requests:

E-mail: [operations-pro@ecologic-france.com](mailto:operations-pro@ecologic-france.com)

Phone: 01 30 57 79 14

Internet: [www.e-dechet.com](http://www.e-dechet.com)

# OPERATING AND COMMISSIONING INSTRUCTIONS

## II. INSTALLATION

### II.1. Handling

The units must only be moved in their installation position.

If the device is handled using a fork-lift truck, ensure this supports the load-bearing structure

If the device is moved using a crane, use four cables of identical lengths. These must be at least as long as the greatest distance between two fastening points.

**If  $L + W + H > 5m$  then the case must be lifted using a lifting beam**

### II.2. Space required

Generally speaking, it is desirable to provide access space of at least the width of the unit on the each side for maintenance. These units require a siphon and must be installed at a sufficient height to allow this to be installed.

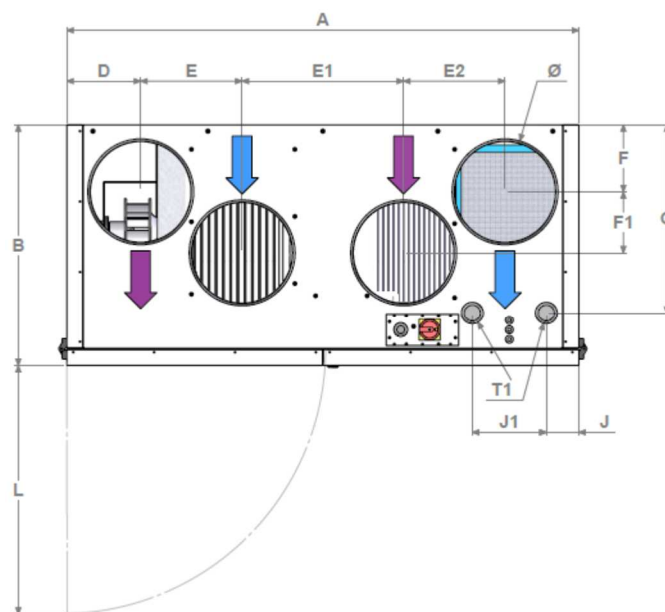
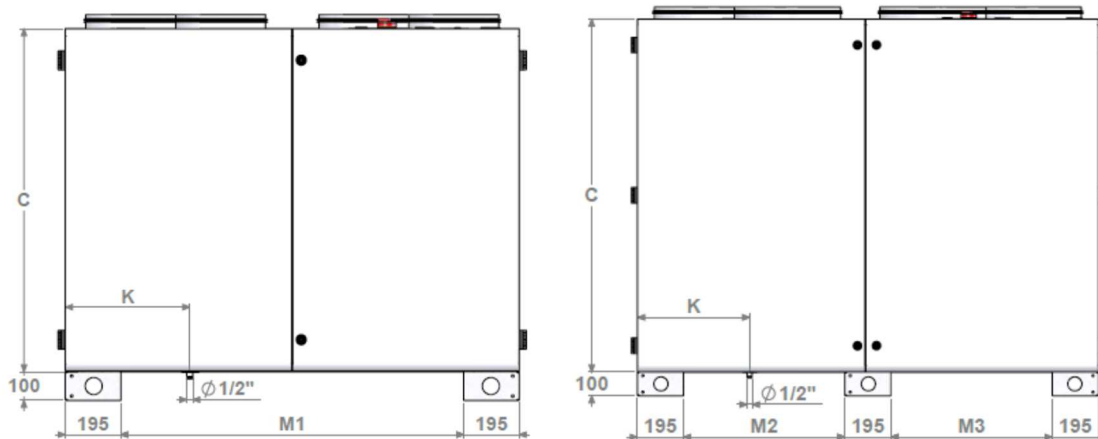

# OPERATING AND COMMISSIONING INSTRUCTIONS

SILVERTOP® Models	Ø	A	B	C	D	D1	D2	E	E1	E2	F	F1
	mm	mm	mm	mm	mm	mm	mm	mm	mm	mm	mm	mm
06	200	1105	570	1040	145	—	—	225	365	225	135	150
08	250	1265	700	1150	170	—	—	235	415	270	160	225
15	315	1590	750	1200	230	—	—	315	500	315	210	190
23	400	1735	1065	1340	270	—	—	330	535	330	250	420
35	450	1950	1210	1495	295	—	—	340	615	405	280	515
52	—	2185	1520	1625	70	405	960	140	140	140	50	260

SILVERTOP® Models	G	J	J1	K	L	M1	M2	M3	T1	SEASON FIRST	PREMIUM BE SMART PREMIUM BC	INFINITE BE INFINITE BC
	mm	mm	mm	mm	mm	mm	mm	mm	inch	kg	kg	kg
06	385	75	130	265	545	720	—	—	1/2"	175	180	185
08	485	75	180	275	625	880	—	—	1/2"	250	255	260
15	585	100	230	435	770	1200	—	—	1/2"	320	330	335
23	765	100	230	440	855	1350	—	—	1/2"	490	500	510
35	805	100	305	475	960	—	685	685	1/2"	635	650	660
52	1115	100	380	525	1120	—	760	760	1"	875	890	905

### II.1. Installation

The unit must be laid on a sufficiently rigid and flat surface (use vibration mounts if necessary). For the HVAC connection, select duct sections based on dimensions of the flexible bands that should be properly stretched. The ducts must be insulated. The unit mustn't the weight of them

Install the unit such that bad weather or ambient temperature cannot damage the internal items of the unit during installation as well as when used later (possibly provide a protective cap).

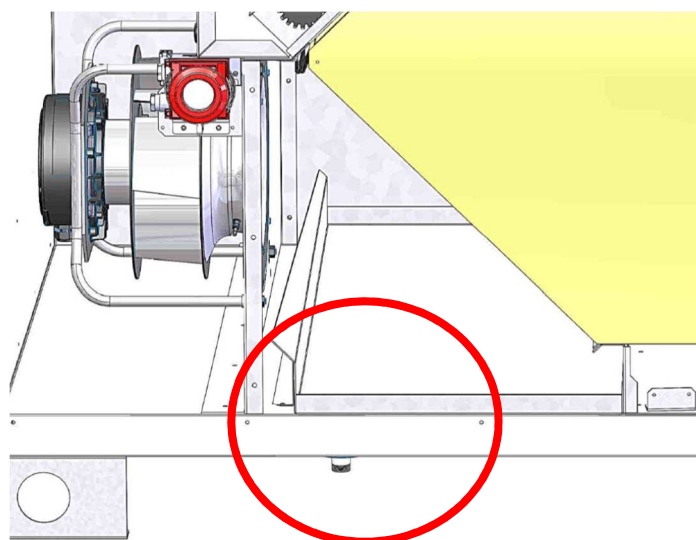

Manually lift the condensate pan to remove the screw in the coil. Then cut the wire feed on the underside to allow the coil to be positioned below the control panel as shown in the photo above. Be careful when cutting the wire feed that serves as a sealing washer.

# OPERATING AND COMMISSIONING INSTRUCTIONS

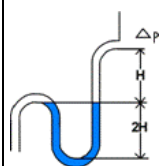

**Provide a siphon on each condensate drainage pipe.** A siphon can only be used for one drainage system. Note: the siphon must be connected in accordance with Best Practices in order that the condensates are removed as efficiently as possible.

The height H must be at least equal to the maximum internal negative pressure of the unit ( $D_p$  in mm).

Example :  $D_p = 500 \text{ Pa @ } 50 \text{ mm CE}$

$\Rightarrow H > 50 \text{ mm} \quad 2H > 100 \text{ mm}$

## III. GENERAL FONCTIONNING

### III.1. GENERAL

**SILVERTOP®** range is a programme of double-flow units with high efficiency recovery, self-regulating recovery meant for office and industrial installations. Its performance is greater than 90%.

**SEASON** : Manages the fans by potentiometers and Bypass. No battery can be associated.

**FIRST** : Economical management of fans and Bypass. Allows managing a non-integrated changeover battery or (hot water battery non-integrated or and cold water battery non integrated) If required, it can also manage a non-integrated electric battery and a non-integrated cold water battery.

**PREMIUM BC** : Economical management of the fans, Bypass and a intergrated hot water battery. If required, it can also manage a non-integrated cold water battery.

**PREMIUM BE** : Economical management of the fans, Bypass and a intergrated electrical battery. If required, it can also manage a non-integrated cold water battery.

**INFINITE BC** : Economical management of the fans, Bypass and a intergrated hot water battery and an integrated defrost battery. If required, it can also manage a non-integrated cold water battery.

**INFINIT BE** : Economical management of the fans, Bypass and a intergrated electrical battery and an integrated defrost battery. If required, it can also manage a non-integrated cold water battery.

**SMART** : Economical management of the fans, Bypass and an integrated defrost battery. If required, it can also manage a non-integrated cold and/or hot water battery.

### III.2. ANALYSE FONCTIONNELLE

Except SEASON version

Starting sequence :

- The supply air fan starts and the fresh air register opens.
- The extract air fan starts and the extract air register opens
- Temperature regulation starts defined in the regulation mode set. Electric heater (if set), starts with airflow controller.

Pumps start.

- After a defined time, alarms management function is activated. Installation is in normal mode.

Start conditions :

Installation starts when one of these conditions are filled:

- Timer normal or reduced are activate
- Manual start is activated with controller
- One of the digital input for extended operation is activated.

Stop sequence :

Installation stops with following process:

- Deactivation of the alarm management function.
- Electric heater stops (if set).
- After a defined time (individually defined for each fan) fans are stopped.
- Supply and return air registers are closed .
- Signals toward actuator are reset and pumps closed

Stop conditions :

Installation stops when one these conditions are filled:

- Timers normal or reduced are not activated and digital input for extended operation is not activated.
- Digital Input for External stop is activated.
- Manual stop is activated with controller
- An alarm configured with stop function is activated. Installation will automatically start when alarm is reset.

# OPERATING AND COMMISSIONING INSTRUCTIONS

### III.3. REGULATION MODE

#### III.3.a. SEASON :

##### 1 Adjustable speeds from potentiometers

Each fan is individually adjustable from integrated potentiometer.

Possibility to add a remote forced stop (in standard on supply contactor (not supplied))

#### III.3.b. ECO :

##### 1 or 2 speeds adjustable with display unit / remote controller / external command « MODE VENTIL (%) »

Adjustment of a minimum speed (LS - 1/2) and a maximum speed (HS - 1/1) in %.

Fitted with a factory turned clocked set :

- (HS - 1/1) from 06h00 to 22h00
- (LS - 1/2) from 22h00 to 06h00

Possibility of adding a remote forced start (LS - 1/2) or (HS - 1/1) (free voltage contact NO)

Possibility of adding a remote forced stop (free voltage contact NO)

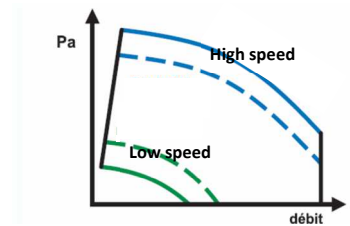

#### III.3.c. DIVA

##### Proportional ventilation between two airflows (LS/HS) with CO2 management « AUTO CO2 MODE »

Adjustment of a minimum speed (LS - 1/2) and a maximum speed (HS - 1/1) in %.

CO2's setpoint is set in factory to 1000ppm (compliant to French RT2012).

Variation between (LS - 1/2) and (HS - 1/1) is managed from CO2 level

Fitted with a factory turned clocked set in (LS - 1/2) from 00h00 to 24h00.

Possibility of adding a remote forced start (LS - 1/2) or (HS - 1/1) (free voltage contact NO)

Possibility of adding a remote forced stop (free voltage contact NO)

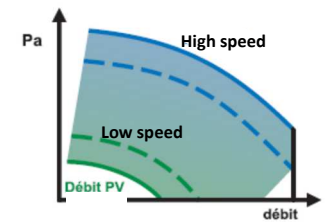

Nota : In order for the CO2 regulation works, installation must follow these constraints :



- Clock (HS - 1/1) is not activated (normal speed timer)
  - Clock (LS - 1/2) is activated (reduced speed Timer)
- External operation (HS - 1/1) and external stop are not activated

#### III.3.d. LOBBY® :

##### Constant pressure ventilation. (Pa) « CONSTANT PA MODE»

Constant pressure adjustment (Pa).

Fitted with a factory turned clocked set in (LS - 1/2) from 00h00 to 24h00.

Possibility of adding a remote forced start (LS - 1/2) (free voltage contact NO)

Possibility of adding a remote forced stop (free voltage contact NO)

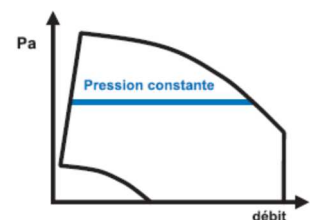

#### III.3.e. MAC2® : (impossible with sizes 06-08)

##### 1 or 2 constant air flow (m³/h) adjustable « MODE CONSTANT M3/H »

Adjustment of a minimum constant air flow (LS - 1/2) and a maximum air flow (HS - 1/1) in m³/h.

Fitted with a factory turned clocked set :

- (HS - 1/1) from 06h00 to 22h00
- (LS - 1/2) from 22h00 to 06h00

Possibility of adding a remote forced start (LS - 1/2) or (HS - 1/1) (free voltage contact NO)

Possibility of adding a remote forced stop (free voltage contact NO)

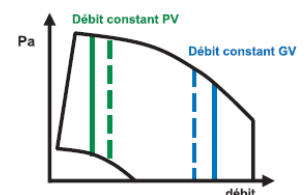



## OPERATING AND COMMISSIONING INSTRUCTIONS

### III.3.f. QUATTRO® : (impossible with sizes 06-08)

#### Proportional ventilation between two constant airflows (m<sup>3</sup>/h) adjustable with CO2 management

Adjustment of a minimum constant air flow (LS - 1/2) and a maximum air flow (HS - 1/1) in m<sup>3</sup>/h.

CO<sub>2</sub>'s setpoint is set in factory to 1000ppm (compliant to French RT2012).

Variation between (LS - 1/2) and (HS - 1/1) is managed from CO<sub>2</sub> level

Fitted with a factory turned clocked set in (LS - 1/2) from 00h00 to 24h00.

Possibility of adding a remote forced start (LS - 1/2) or (HS - 1/1) (free voltage contact NO)

Possibility of adding a remote forced stop (free voltage contact NO)

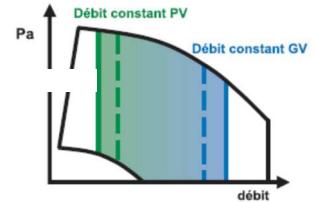

Nota : In order for the CO<sub>2</sub> regulation works, installation must follow these constraints :



- Clock (HS - 1/1) is not activated (normal speed timer)
- Clock (LS - 1/2) is activated (reduced speed Timer)
- External operation (HS - 1/1) and external stop are not activated.

### III.4. COMPOSITION

#### III.4.a. SEASON

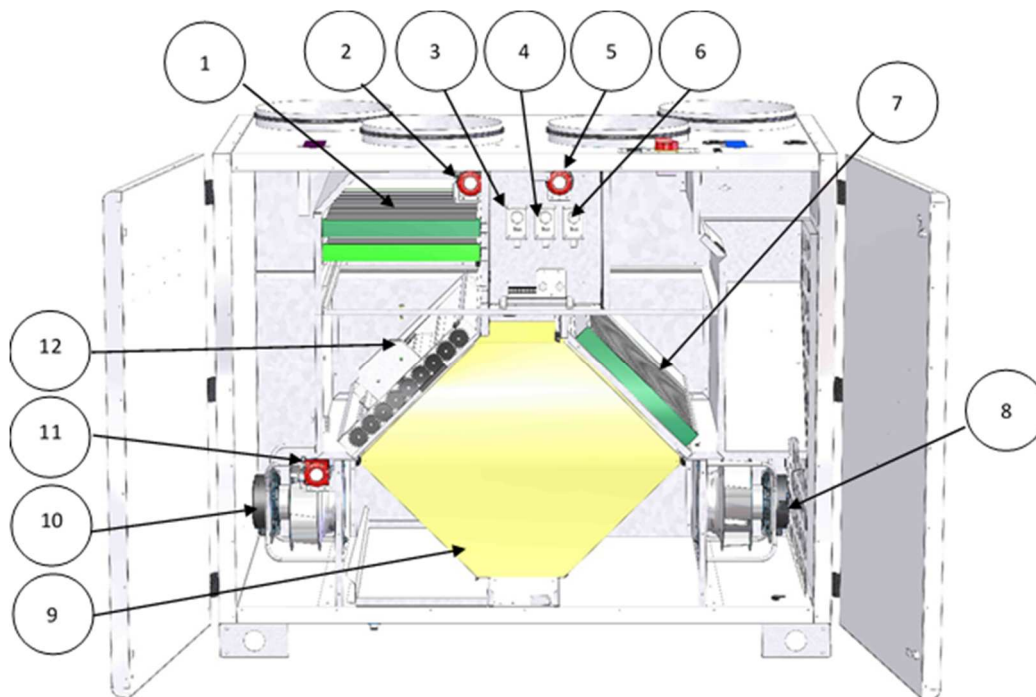

N°	Détails
1	Supply filter FS
2	Filter pressure switch DEPFS
3	TH1 Thermostat for outdoor winter setpoint (+18°C)
4	TH2 Thermostat for outdoor summer setpoint (+24°C)
5	Supply pressure switch DEPS
6	TH3 deicing thermostat (+5°C)
7	Extract Air fan (VAR/VR)
8	Extract filter FR
9	Supply air fan (VAS/VS)
10	Plate exchanger + condensate parts
11	Extract pressure switch DEPS
12	Bypass + actuator

### OPERATING AND COMMISSIONING INSTRUCTIONS

#### III.4.b. ECO-DIVA-MAC2-QUATTRO

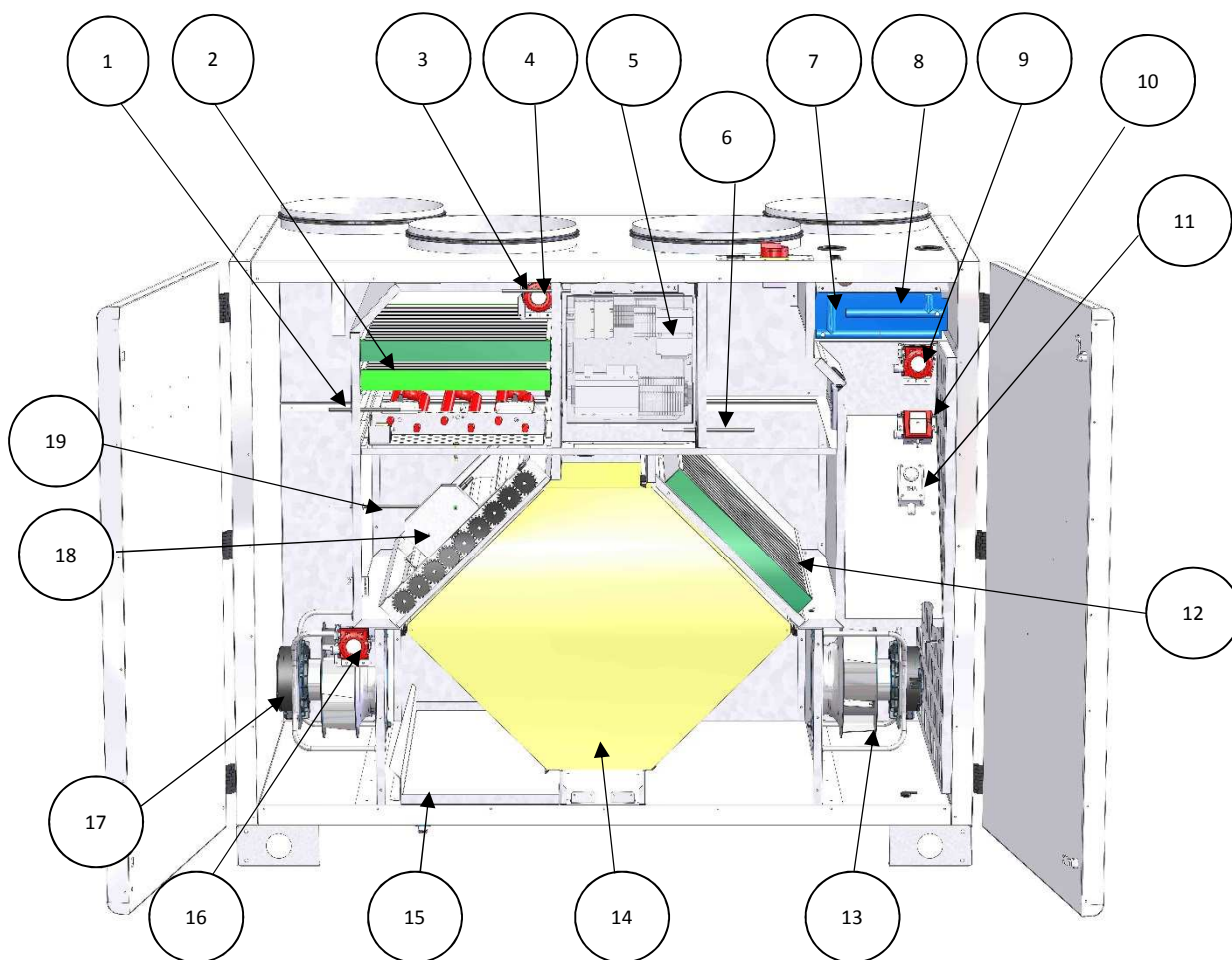

N°	Détails
1	Deicing temperature sensor SDG
2	Supply filter FS
3	Filter pressure switch DEPFS
4	Outdoor temperature sensor SEG
5	Control cabinet
6	Extract temperature sensor SRG
7	Hot water battery (version BC) ou electrical battery (version BE)
8	Supply température sensor SSG
9	Supply pressure switch DEPS (version ECO-DIVA) Supply pressure transmitter (version LOBBY-MAC2-QUATTRO)
10	Extract pressure transmitter (version LOBBY)
11	External frost guard THA (version BC) or Manual High supply air thermostat (verison BE)
12	Extract filter FR
13	Supply air fan (VAS/VS)
14	Plate échangeur
15	Condensate pan
16	Extract pressure switch DEPR (version ECO-DIVA) Supply pressure transmitter (version MAC2-QUATTRO)
17	Extract air fan (VAR/VR)
18	Bypass + Actuator
19	Deicing battery (version SMART et INFINITE) witch deicing temperature sensor SBD and security thermostat THSD

# OPERATING AND COMMISSIONING INSTRUCTIONS

### III.5. ELEMENTS IN THE REGULATION

#### III.5.a. REGULATION ECO/DIVA/LOBBY/MAC2/QUATTRO

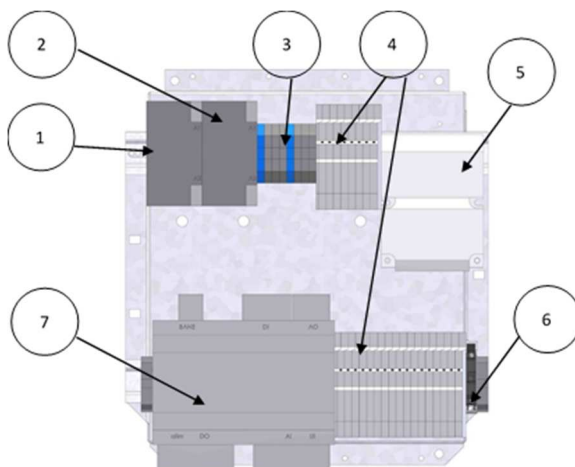

N°	Nom	Détails
1	K1	Heating Electrical battery contactor
2	KD	Deicing electrical battery contactor
3	BORNIER	Fans terminal blocks
4	BORNIER	Terminal blocks
5	TRAFO	Transformer 230/24V
6	BFUS	Fuse terminal blocks
7	REGULATEUR	Controller CORRIGO E283W3

## IV. ELECTRIC WIRING

### IV.1. POWER SUPPLY

SILVERTOP® Model	Electrical motor power (W)	Temp. Use (°C / °C)	Electrical safety rating	Thermic protection*	SEASON & FIRST & PREMIUM BC		INFINITE BC & SMART		PREMIUM BE		INFINITE BE	
					Electrical supply voltage (V / Ph / Hz)	Electric charge protection (A)	Electrical supply voltage (V / Ph / Hz)	Electric charge protection (A)	Electrical supply voltage (V / Ph / Hz)	Electric charge protection (A)	Electrical supply voltage (V / Ph / Hz)	Electric charge protection (A)
06	2 x 169 W	-20 / 60	IP54 / B	PTI	230 / 1 / 50	3,4	230 / 1 / 50	8,8	230 / 1 / 50	8,8	230 / 1 / 50	14,2
08	2 x 170 W	-20 / 60	IP54 / B	PTI	230 / 1 / 50	4,0	230 / 1 / 50	14,8	230 / 1 / 50	14,8	230 / 1 / 50	25,7
15	2 x 480 W	-20 / 40	IP54 / B	PTI	230 / 1 / 50	4,9	400 / 3+N / 50	9,7	230 / 1 / 50	21,2	400 / 3+N / 50	15,1
23	2 x 750 W	-20 / 40	IP54 / B	PTI	230 / 1 / 50	7,2	400 / 3+N / 50	13,0	400 / 3+N / 50	13,0	400 / 3+N / 50	22,8
35	2 x 1000 W	-20 / 50	IP54 / B	PTI	400 / 3+N / 50	3,8	400 / 3+N / 50	21,2	400 / 3+N / 50	19,0	400 / 3+N / 50	36,3
52	2 x 1700 W	-20 / 40	IP54 / B	PTI	400 / 3+N / 50	5,8	400 / 3+N / 50	27,4	400 / 3+N / 50	23,1	400 / 3+N / 50	44,7

\* PTI : Included Thermic Protection

### IV.2. CONTROL WIRING (SEASON)

All components were wired in factory (voir chapitre schéma complet)

# OPERATING AND COMMISSIONING INSTRUCTIONS

### IV.2.a. Remote alarm

Possibility to connect a remote alarm directly on pressure switch (5A/230VAC max and 4A/24VDC max) :

- DEP S = Supply pressure switch
- DEP R = Extract pressure switch
- DEP FS = Filter pressure switch (NO contact is available on terminal blocks 25-26)

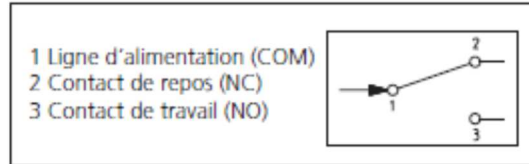

### IV.2.b. External 0-10V (potentiometer)

You have the possibilities to replace the factory potentiometer by remote potentiometer or external 0-10V. To connect an external component, disconnect wires at the rear of the factory potentiometer and connect it directly on these wires. Pour connecter un élément externe, débrancher les fils à l'arrière des potentiomètres et raccorder vous directement sur ces fils

#### Actual wiring

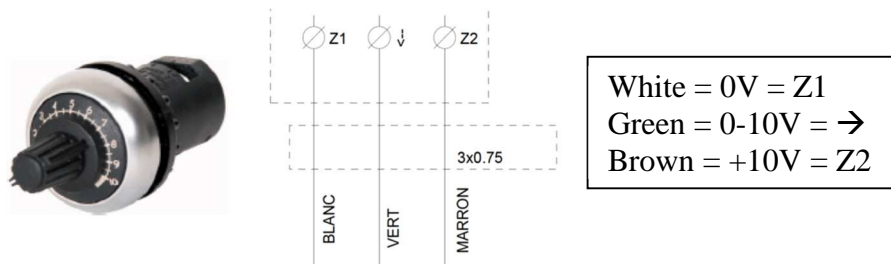

### IV.2.c. Bypass

Thermostat are factory set :

TH1 = Outside temperature for heat recovery via exchanger (factory setting 18°C)

TH2 = Outside temperature for cool recovery via exchanger (factory setting 24°C)

The bypass is factory wired

its functioning is automatic automatique thanks to the two thermostat :

Winter : If outside temperature is lower than 18°C (adjustable), the Bypass closes to recover a maximum of calories.

Summer :

COOL RECOVERY : If outside temperature is higher than 24°C (adjustable) the bypass closes to recover a maximum of calories.

FREE COOLING : If outside temperature is between 18°C and 24°C (adjustable), the bypass opens to bring directly fresh air into the building

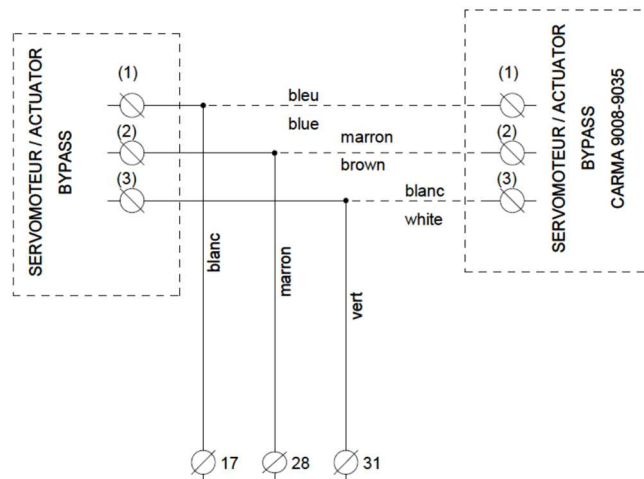

# OPERATING AND COMMISSIONING INSTRUCTIONS

### IV.2.a. Automatic deicing

Deicing is done by opening the Bypass as soon as the deicing temperature (SDG) falls below 5 ° C (thermostat installed at discharge). As soon as the temperature returns above + 5 ° C the bypass closes again.

### IV.3. CONTROL WIRING (ECO/DIVA/LOBBY/MAC2/QUATTRO)

#### IV.3.a. Temperature sensor

Temperature sensors are connected on the regulator

- **SSG** : Duct supply temperature sensor on Agnd(30) et AI1(31)
- **SEG** : Duct outdoor temperature sensor on Agnd(30) et AI2(32)
- **SDG** : Duct deicing temperature sensor on Agnd(33) et AI3(34)
- **SRG** : Duct extract temperature sensor on Agnd(33) et AI4(35)
- **SBD** : Duct deicing battery temperature sensor on Agnd(36) and AI4(37) on SMART et INFINITE versions (replaced by a 1030 Ohms resistance on other versions)

#### IV.3.b. Terminal blocks

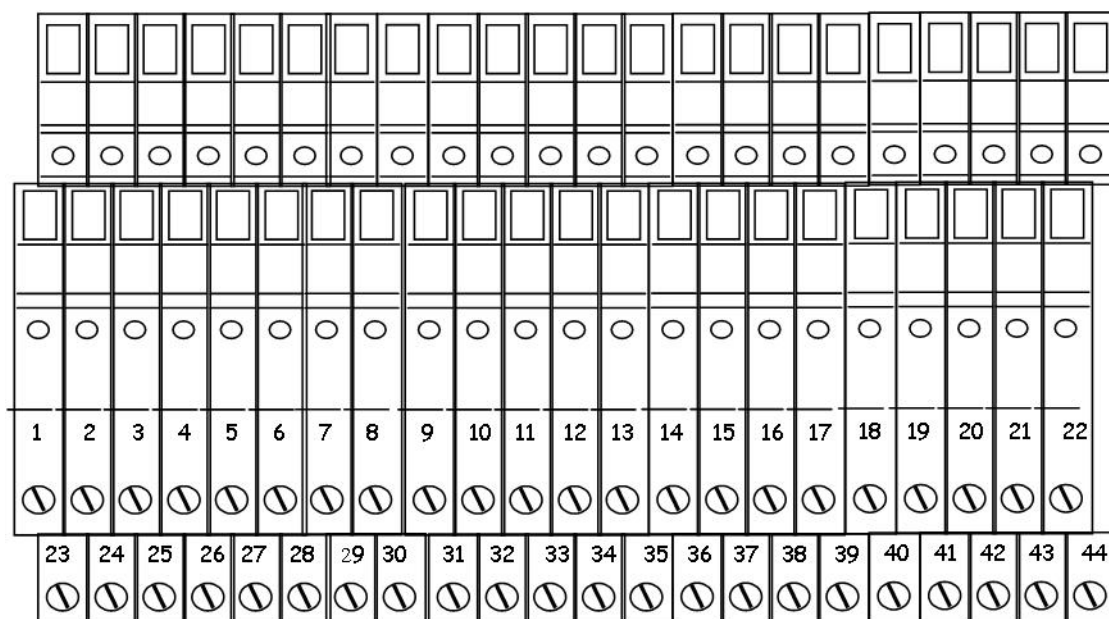

Désignation	Bornes	Raccordement
<b>ADP (shunted if not used)</b>	1-2	Connect on fire emergency stop (free voltage NC contact)
<b>DAD (shunted if not used)</b>	3-4	Connect on DAD (smoke detector) default contact (NC)
<b>THA/THS (shunted if not used)</b>	5-6	Connect to NC free voltage contact of THA (PREMIUM BC and INFINITE BC) Or Connect to NC free voltage contact of THS (PREMIUM BE et INFINITE BE)
<b>ED-TOUCH</b>	7-8 + A*-B* (port2)	Connect to remote touch screen display
<b>MF PV</b>	9-10	Connect to NO free voltage contact of reduced Speed extended operation
<b>MF GV</b>	11-12	Connect to NO free voltage contact of normal Speed extended operation
<b>ARR EXT</b>	13-14	Connect to NO free voltage contact of external stop

## OPERATING AND COMMISSIONING INSTRUCTIONS

<b>BC</b>	15-16-17	<b>BC</b> :Connect to 3 ways valve of the hot water battery (cf chapter IV.12)
<b>BE</b>	18 + DO3**	<b>BE</b> : Connect to static contactor of the electric battery (see chapter IV.14)
<b>Heating pump (PREMIUM BC/CO)</b>	18 + DO3**	Connect to hot water circulator (Note : 24V 2AMax to relay) (see chapter IV.12)
<b>Cooling pump</b>	19 + DO4**	Connect to cold water circulator (Note : 24V 2AMax to relay)** (see chapter IV.12)
<b>AL</b>	20 + DO5**	24V output available if unit is in default (Note : 24V 2A Max to relay)
<b>DBE</b>	21 + DO6**	Connect to static contactor of the defrost battery (see chapter IV.15)
<b>NC (Night cooling) (LOBBY®)</b>	22 + DO7**	24V output available if unit runs with the optional LOBBY EC for opening dampers during Night Cooling. (pay attention : 24V 2A Max to relay)
<b>TRPS (LOBBY® MAC2® QUATTRO®)</b>	23 Agnd* + UI2*	Connect to supply Pressure Transmitter (see chapter IV.8)
<b>DEPS (ECO® DIVA®)</b>	24 + UI2*	Connect to terminal 1 and 3 of supply pressure switch (see chapter IV.7)
<b>TRPR (LOBBY® MAC2® QUATTRO®)</b>	25 Agnd* + UI3*	Connect to return pressure Transmitter (see chapter IV.8)
<b>DEPR (ECO® DIVA®)</b>	26 + UI3*	Connect to terminal 1 and 3 of return pressure switch (see chapter IV.7)
<b>CO2 (DIVA®)</b>	27 Agnd* UI4*	Connect to <b>CO2 sensor</b> (see chapter IV.10) DIVA/QUATTRO option
<b>BF</b>	28-29-30	<b>BF</b> : Connect to 3 ways valve of the cold water battery(see chapter IV.12)
<b>DEP FS DEP FR</b>	31-32 33-34	Connect to terminal of exhaust filter switch (see chapter IV.6) Connect to terminal 1 and 3 of return filter switch (see chapter IV.6)
<b>RMS</b>	35 + DO1**	Connect to fresh air damper actuator
<b>RMR</b>	36 + DO2**	Connect to extract air damper actuator
<b>BIM</b>	37-38-39	Connect to Bypass Actuator (see chapter IV.4)
<b>0-10V S</b>	40-41	Connect to Supply air fan (cf chapitre annexes)
<b>0-10V R</b>	42-43	Connect to Extract air fan (cf chapitre annexes)

\* connected directly to CORRIGO controller

\*\* connected directly to CORRIGO controller -8A max on all DO

### **IV.4. Electrical wiring and functioning of the plate exchanger**

Bypass's actuator of the exchanger is factory mounted

CORRIGO controller drives automatically the bypass thanks to programmation and sensor mounted in standard.

In winter: when heat is needed, bypass is closed to recover maximum of calories. If it is not enough to reach the temperature setpoint, hot battery starts running.

In summer :

**COLD RECOVERY** : if outside temperature is higher than inside temperature and cold is needed , bypass closes to recover maximum of calories. If it is not enough to reach the setpoint, cold battery starts running.

**FREE COOLING** : if outside temperature is lower than inside temperature and cold is needed , bypass opens to bring directly outside fresh air. If it is not enough to reach temperature setpoint cold battery starts running.

# OPERATING AND COMMISSIONING INSTRUCTIONS

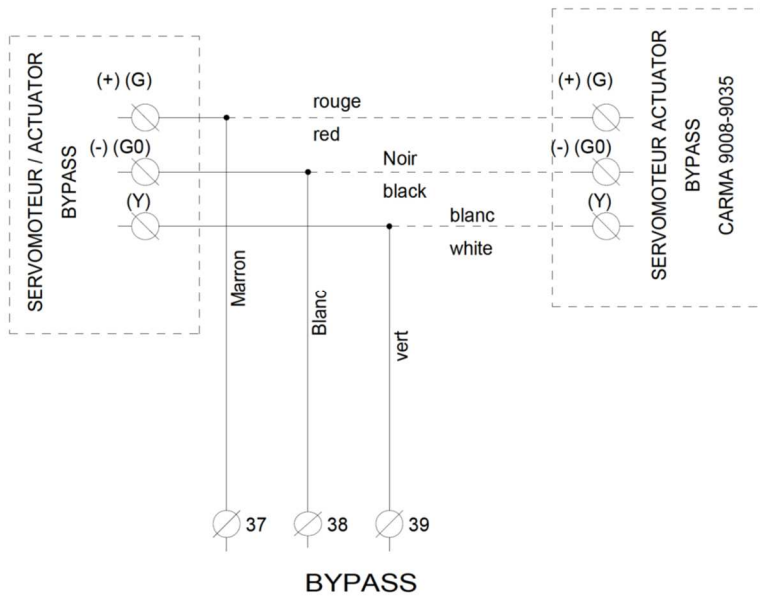

## IV.5. Automatic deicing

This non adjustable function is automatically driven thanks to the programming of CORRIGO controller and sensors mounted in standard in our double flow units. Defrost starts with bypass opening when defrost temperature (SDG) is lower to 5°C (sensor installed on exhaust). In case of Bypass is not enough to defrost the exchanger (if outside temperature is lower to 10°C), fresh air fan modulates the airflow in order to maintain a 5°C temperature of the defrost sensor.

**For INFINITE BE and INFINITE BC/CO and SMART versions:** defrost battery is mounted on fresh air before plate exchanger. It regulates a -5°C temperature in the exchanger. This will avoid any frost risks and maintain Bypass as closed as possible. This maintains a maximum efficiency of the system. In case defrost battery is not enough to defrost plate exchanger, Bypass modulation, and then fan modulation will start as explained above.

## IV.6. Filters pressure switches wiring and connection

Fresh air filter pressure switch is factory connected

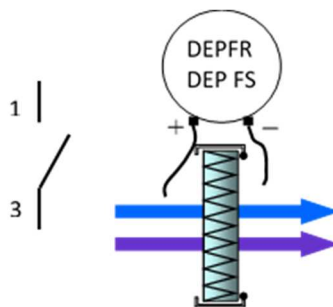

## IV.7. Fan switches wiring and connection

Fans switches are factory cabled and connected

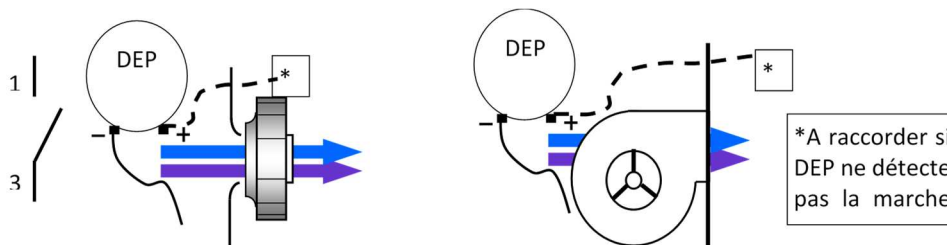

**OPERATING AND COMMISSIONING INSTRUCTIONS**

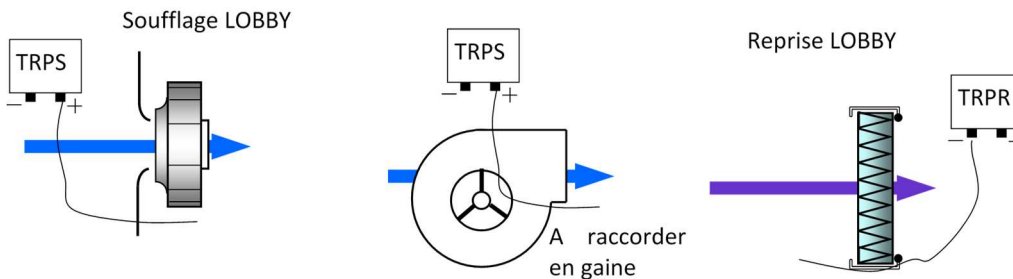
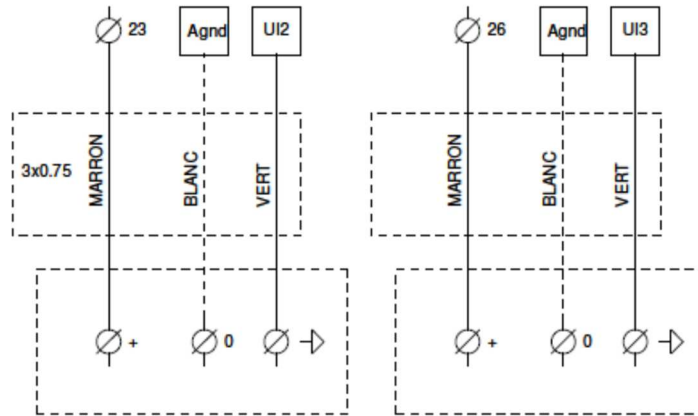

**IV.8. Pressure transmitter LOBBY® MAC2® QUATTRO® wiring and connection**

**IV.9. Motors wiring**

See Annexes chapter

**IV.10. CO2 transmitter wiring**

CO2 transmitter is factory connected (option DIVA/QUATTRO)

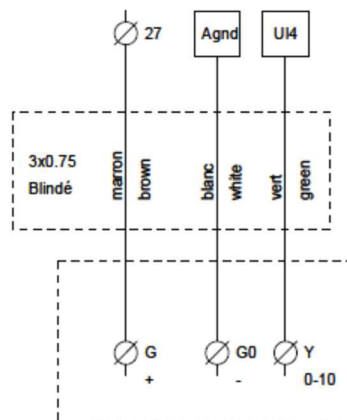

**IV.11. Night Cooling**

This function is used during summer to cool down buildings during nights with outside cool air. It decreases the cold needs during days. Night Cooling function runs only from 00:00 AM to 7:00 h AM. During Night Cooling, hot and cool outputs are locked on 0V. Exchanger runs only with fresh air. At the end of Night Cooling period heating is blocked to 0V during 60 minutes. Start conditions: customizable in chapter V.5.b.2



### OPERATING AND COMMISSIONING INSTRUCTIONS

- Outside temperatures are higher to 22°C during the day.
- Clocks are setted in LS or stopped during 00h00 and 07h00.
- Outside temperature is lower than 18°C during Night Cooling period
- Outside temperature is higher to 10°C during Night Cooling period
- Room temperature is higher to 18°C

During Night Cooling period fans are running 85% of their capacity. This speed is adjustable (see chapter V.5.b.2)

For LOBBY versions, a 24V output (to relay) is available between 22 and DO7 terminals to force the opening of damper's zone during Night Cooling period.

#### IV.12. Hot water / cool water or changeover water coil

**For PREMIUM CO and INFINITE CO units plan to install a siphon for the condensates.**

Pay attention to let the doors free of access (ducts, cables)

Battery is mounted in the unit, antifreeze Thermostat is connected. You have to cable the 3 ways valve. If a cold battery is used or changeover battery in duct is used, move the supply sensor after the battery.

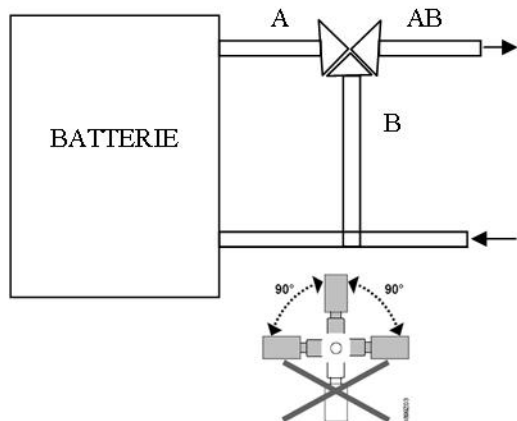

#### 3 WAYS VALVE MUST BE CONNECTED WHEN POWER IS OFF

Connect the servomotor of the 3 ways valve as following instructions:

*Hot Battery :*

Terminal **15** on +24V (G) of the 3 ways valve actuator

Terminal **16** on 0V (G0) of the 3 ways valve actuator

Terminal **17** on 10V (Y) of the 3 ways valve actuator

Connect NC contact (C et 2) of the **THA** (Deicing Thermostat) on **5** and **6**.

Possibility to connect the circulator on the **DO3** terminal of the regulator and the terminal block **18**.

(Note: 24V output to relay)

*Cold Battery :*

Terminal **28** on +24V (G) of the 3 ways valve actuator

Terminal **29** on 0V (G0) of the 3 ways valve actuator

Terminal **30** on 10V (Y) of the 3 ways valve actuator

Connect NC contact (C and 2) of **THA** (Deicing Thermostat) on **5** and **6**

Possibility to connect the circulator on the **DO4** terminals of the regulator and the terminal block number **19**.

(Note: 24V output to relay)

*Changeover battery:*

The changeover thermostat must be connected to the water inlet before Bypass.

You must cable 3 ways valve to the changeover thermostat.

Connect them following the instructions below :

Red wire to the changeover thermostat (CO) on 10V (Y) of the valve

Terminal **15** on +24V (G) of the 3 ways valve actuator

Terminal **16** on the 0V (G0) of the 3 ways valve actuator

Terminal **17** connected to the brown wire of the changeover thermostat (Heat signal)

Terminal **30** connected to the black wire of the changeover thermostat (Cold signal)

Connect the NC contact (C and 2) of **THA** (Deicing Thermostat) on **5** and **6**

# OPERATING AND COMMISSIONING INSTRUCTIONS

Possibility to connect the circulator on the **DO3** terminal of the regulator and the terminal block **18** (heat demand) and on the **DO4** terminals of the regulator and the terminal block number **19** (cold demand). (Note: 24V output to relay)  
**ATTENTION In this case use a relay for each exit and cable in parallel on the ON/OFF of the circulator.**

### IV.13. DX battery (cold or reversible)

For units equipped with direct expansion battery, additional module is equipped with a drain pan. Plan to make a duct of the condensates with a siphon.

At your disposal :

- 24 V output when unit is on cold or heating needs.
- 0-10V hot output and a 0-10V cold output.

Heating needs :

- 24V output: to connect to **DO3 terminals of the controller and 18 of the terminal block**. It allows the start to drive the direct expansion battery module (Attention 24V 2A Max to relay)
- 0-10V output: to connect to **15 and 16 terminals(15=0V et 16 =0/10V)**

Cold needs:

- 24V output: to connect to **DO4 terminals of the controller and 19 of the terminal block**. It allows the start to drive the direct expansion battery module (Attention 24V 2A Max to relay)
- 0-10V output: to connect to **29 and 30 terminals (29=0V et 30 =0/10V)**

**ATTENTION:** In case of a 24V output is used, make a relay between each output and cable them in parallel on the M/A of the direct expansion module.

**ATTENTION:** The command 24V et 0-10V start do not manage any safety or, **anti court cycle ...** of the direct expansion module.

### IV.14. Electrical Battery

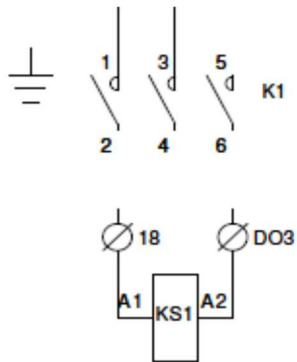

SILVERTOP 06-08  
SILVERTOP 15 PREMIUM BE

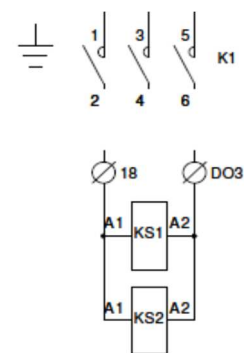

SILVERTOP 15 INFINITE  
SILVERTOP 23-52

### OPERATING AND COMMISSIONING INSTRUCTIONS

#### IV.15. Deicing battery

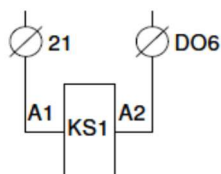
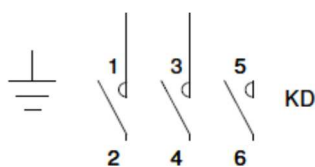

SILVERTOP 06-08

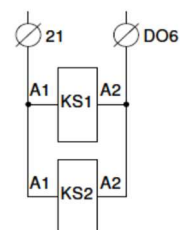
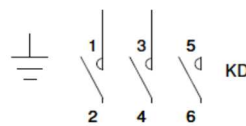

SILVERTOP 15-52

#### IV.16. Fire function

See configuration chapter V.8

There are 2 ways to drive the fire function:

- Emergency Fireman stop: cable between 1 and 2 terminals (NC free voltage contact). Total stop of the central control. (no display available)
- Fire alarm: this function controls exhaust and return fans with 5 modes available in the parameters of the regulation (the function can be activated on site). "fire alarm" will be on the display.
  1. « **stop** » : complete stop of the unit
  2. « **continuous work** » : Start of the unit in HS, fire function will have priority on all the other alarms.
  3. « **Normal work** » : keeps the unit running with parameters activated on site (Stop/LS/HS)
  4. « **Supply fan only** » : start or keeps in HS the supply fan (extract stopped)
  5. « **Extract fan only** » : starts or keeps in HS the extract fan (supply stopped)

Digital input « external stop » is priority on fire function.



This function is not adapted anymore to the French market and will be in all cases validated by the control office.

Digital input fire alarm will be connected between **DI8 terminal of the controller and 13 of the terminal block (free voltage contact required)**

#### IV.17. Dehumidification function

See configuration chapter V.8

It is possible to associate the unit to a COMBIBOX CONCEPT® module equipped with a cold battery (water or cold direct expansion module only) followed by a hot battery (water or electric or hot direct expansion module DX heat). In this case controller will manage automatically the heating or cold inputs for the dehumidification and will keep an ideal functioning temperature. During cold needs period, the temperature management will have priority on dehumidification.



Function non available in DIVA and QUATTRO mode

Connect batteries as indicated in chapters IV.12, IV.14

Install the humidity duct sensor in supply or extract air, following the humidity control mode.

Connect the humidity sensor as following instructions :

# OPERATING AND COMMISSIONING INSTRUCTIONS

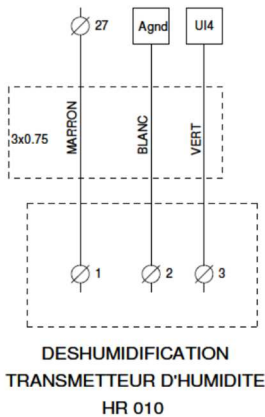

### IV.18. MODBUS / WEB / BACNET wiring

((see parameters in chapters V.8)

**MODBUS RS485 and BACNET MSTP:** Use armoured cable 2 crossed pairs wire type BELDEN 8723 or similar to connect BMS to controller (to connect to port 1 (BANE) / connect armour to N and don't connect E)

**WEB / MODBUS TCP/IP et BACNET IP:** to connect to TCP/IP port

**BMS : en standard**

- MODBUS / RS485 ou TCP/IP
- WEB / TCP/IP
- BACNET / TCP/IP ou MSTP
- EXO / TCP/IP

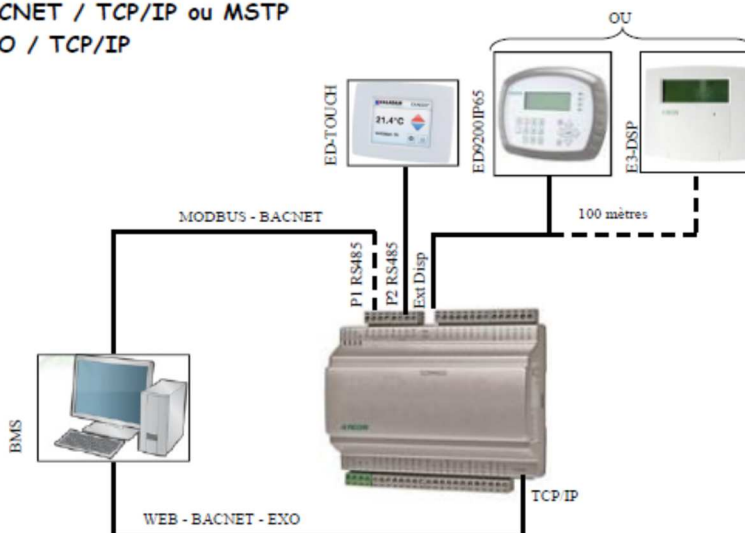

### IV.19. Repeater wiring

(voir paramétrage chapitre V.8)

You need to use a repeater in case of you want to connect:

- More than one unit on the same display (maximum 6)
- A remote control at a distance higher than 100m

In this case you can move to 1 kilometer the remote control. Use 2 crossed wire type BELDEN 8723 or similar between repeater and controller. Supply repeater in 230V single mono phase.

Connect on port 1 the wires as following instructions :

# OPERATING AND COMMISSIONING INSTRUCTIONS

- B of repetitor on B terminal of the regulation board (armour wire as in drawing under)
- A of repetitor on A terminal of regulation board (armour wire as in drawing under)
- N of repetitor on N terminal of regulation board (armour wire as in drawing under)

**Plan a 230V single phase power supply on the repetitor.**

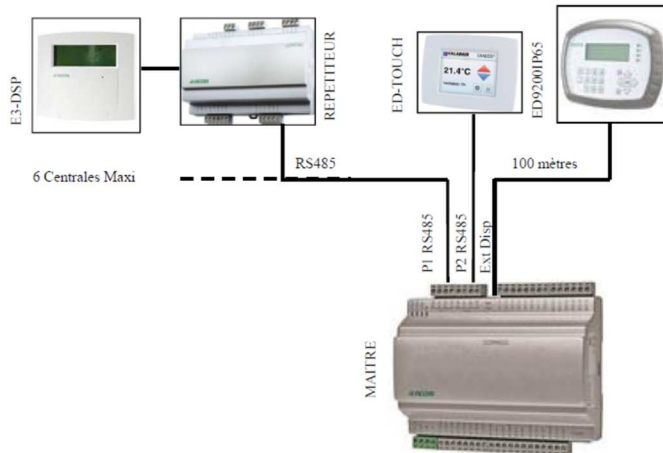

## IV.20. LON

(see configuration in chapter V.8) Cable port 2 of master on port 1 of LON controller

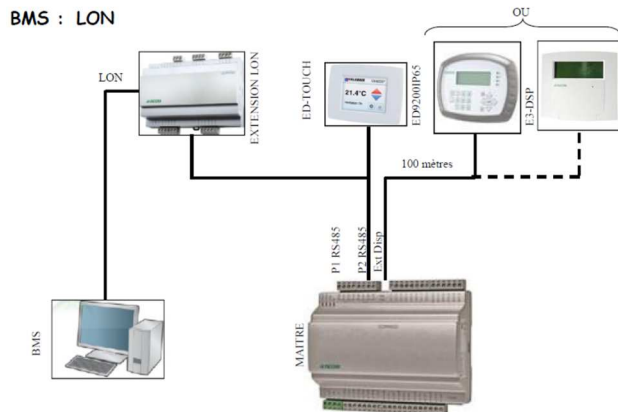

## V. SETTINGS

### V.1. Display (RJ9 4P4C)

There are four lines of twenty characters on the backlight display. The light only starts when a button is pushed. It stops after an inactivity period.

There are 2 LED on the front of the display:

LED of the alarm is a bell symbol.

LED for the writing with a pen symbol.

- Quick blinking = you can modify the value

- Slow blinking = you must enter a password to modify the value

- Directional arrows up, down left and right help to navigate in the menus.
- Up and Down buttons help to increase or decrease the values of a parameter when you have access to. Right and left buttons help to navigate inside the parameter.
- OK button help to enter the value and to confirm a choice. C button helps to cancel it.
- Alarm button (red) allows the access of the defaults list.
- Left arrow also helps to go out of the alarm menu and go back to the main menu
- Cursors indicate the possible movements and which arrows to press.



# OPERATING AND COMMISSIONING INSTRUCTIONS

Directional arrows MENU)

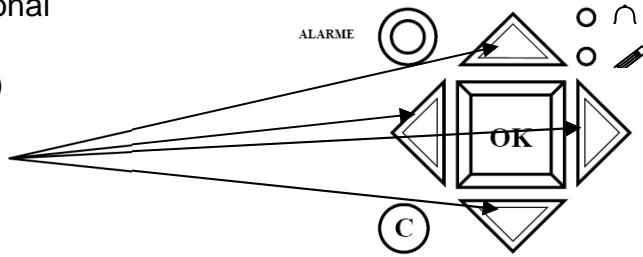

Cursor

Possibility to up

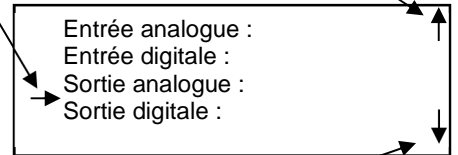

Possibility to down

## V.2. Exemple of setting

- Move the cursor to the required menu

In the required menu:

Hour : ex : **10:33**  
Date : ex : **08/12/23** (year/month/day)  
Day : ex : **Mardi**

press OK

Enter the password if necessary

- Enter the required value with arrows or with numerical keyboard
- Press OK to valid and go to next step.

When values are updated press the left arrow to come back to the welcome screen

## V.3. Standard settings (opérateur menu)

Words in normal writing = viewing only / **Words in bold** = Modification is possible / **Outlined words in bold** = Modification is possible with password 3333 ... = non accessible or not used

**ATTENTION : Do not modify parameters which are not in bold characters, in this case no after sales will be admitted**

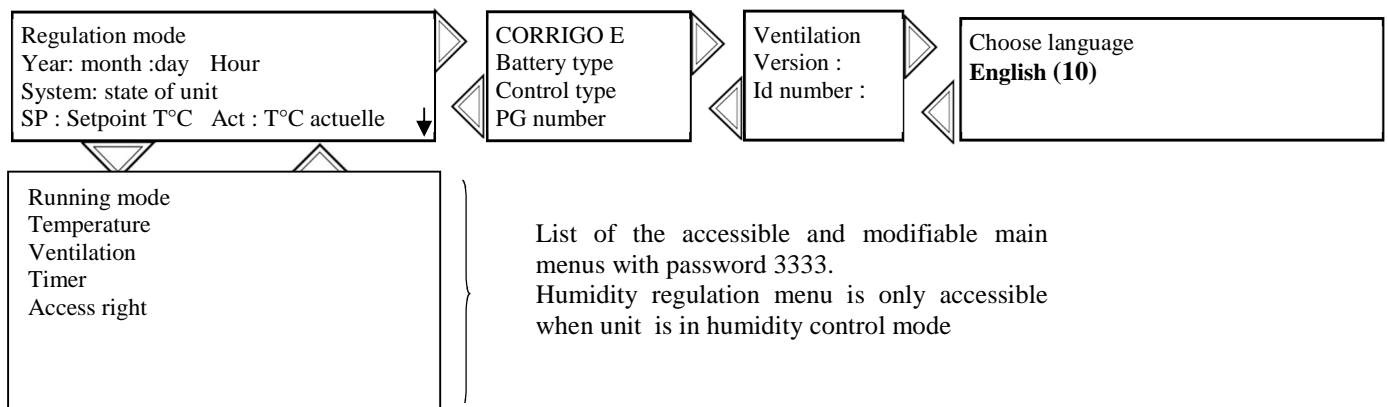

List of the accessible and modifiable main menus with password 3333.  
Humidity regulation menu is only accessible when unit is in humidity control mode

**(10) Language setting (see chapter V.4.e)**

**OPERATING AND COMMISSIONING INSTRUCTIONS**

V.3.a. Running mode menu

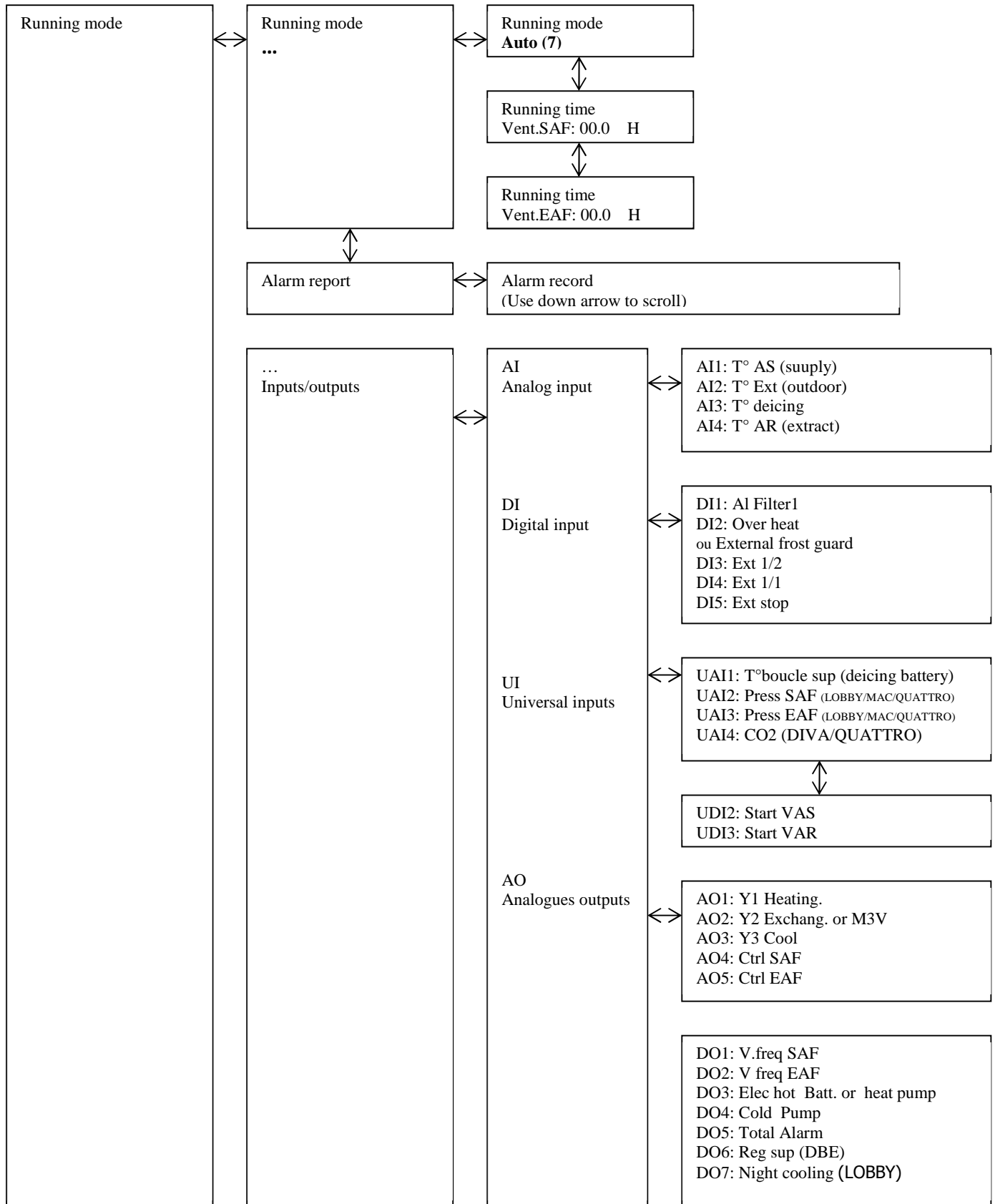

(7) **Unit Start/Stop (see chapter V.4.d)**

**OPERATING AND COMMISSIONING INSTRUCTIONS**

V.3.b. Temperature menu

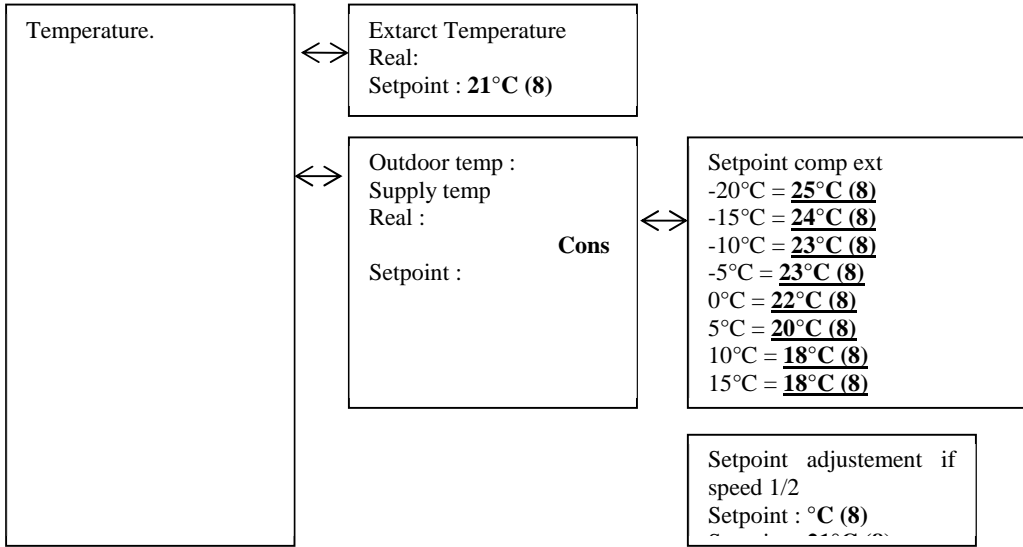

(8) Temperature setpoint setting (see chapter V.4.c)

V.3.c. Ventilation menu

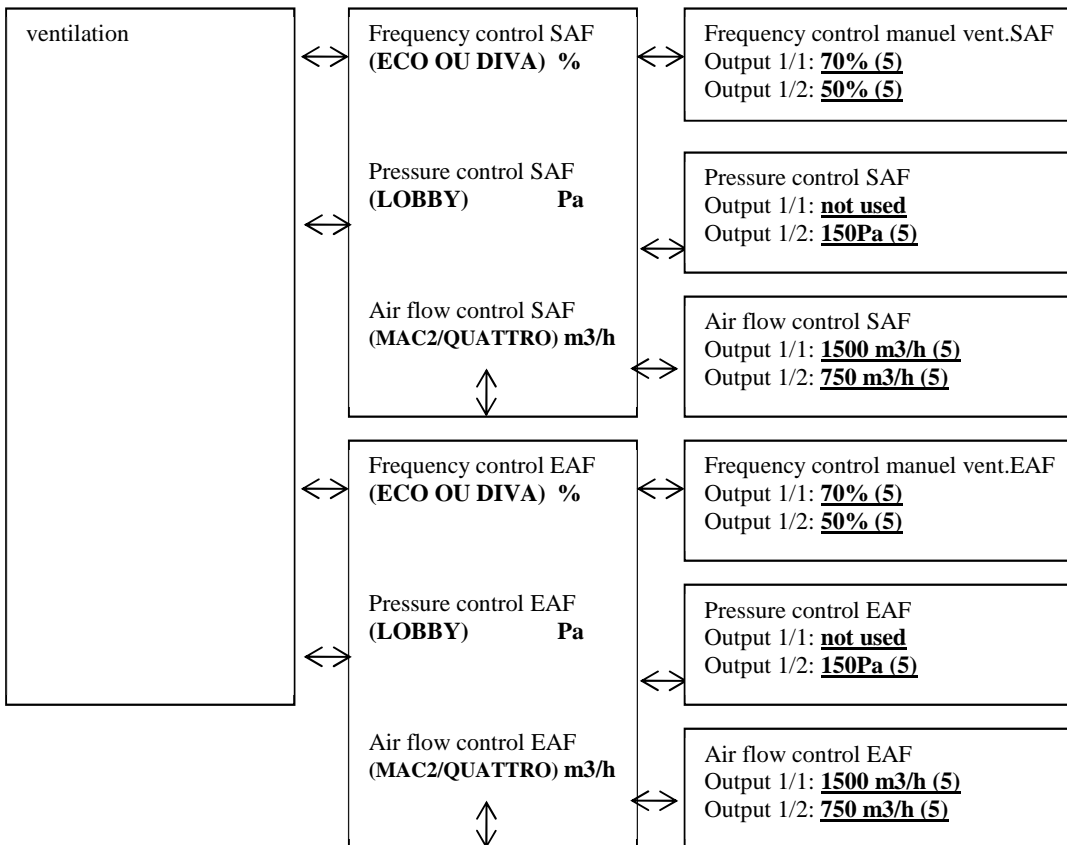

(5) Speeds, pressures, airflows (see chapter V.4.b)



### OPERATING AND COMMISSIONING INSTRUCTIONS

#### V.3.d. Timer menu

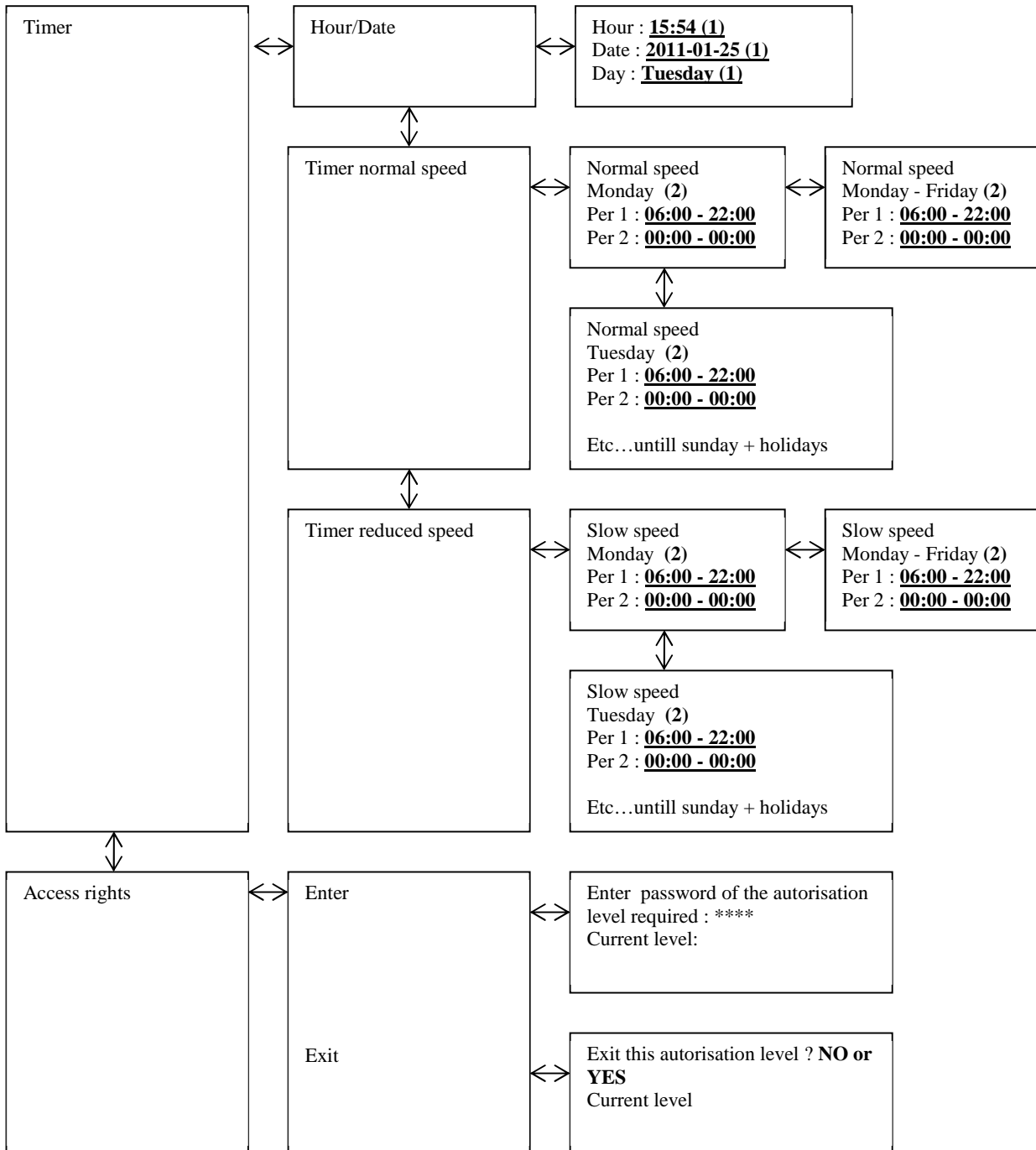

1. Hour and date setting (see chapter V.4.a)
2. HS program setting (see chapter V.4.a)
3. LS program setting (see chapter V.4.a)
4. Holidays period setting (see chapter V.4.a)

# OPERATING AND COMMISSIONING INSTRUCTIONS

## V.4. Operator parameters modification ( password 3333 required)

### V.4.a. Dates and hours clocks setting

#### V.4.a.1. *Date and hour of the CORRIGO controller [(1) chapter V.3.d]*

Access : Hour Date setting

Date and hour of the regulator are set by default in the CORRIGO controller. Summer/Winter time is automatically managed.

#### V.4.a.2. *Hour programming of the functioning system [(2) (3) chapter V.3.d]*

Access :

- **Timer normal speed** : Time settings / normal speed programm
- **Timer reduced speed** : Time settings / slow speed programm

System is set to work in normal speed (HS-1/1) **07:00 - 22:00** in slow speed (LS-1/2) **22:00 - 06:00** except DIVA / LOBBY / QUATTRO versions which work in slow speed (LS-1/2)

As indicated in arborescence you also have the possibility to modify Monday to Friday periods by pressing the right button when you are on the Monday screen

Nota : if slow speed (LS-1/2) and normal speed (HS-1/1) are activated in the same time window, unit works in high speed  
Operation exceptions:



DIVA®/QUATTRO® : For CO2 regulation do not activate any normal speed time window (GV-1/1)

LOBBY: Only slow speed clock (LS-1/2) must be activated

NIGHT COOLING: Only works if unit is in slow speed (LS-1/1) between 00:00 and 07:00.AM (Example: If unit is in (LS-1/2) between 02:00 and 06:00 and in (HS-1/1) the rest of the time. Then NIGHT COOLING is allowed to work only from 02:00 to 06:00 AM)

#### V.4.a.3. *Vacation time [(4) chapter V.3.d] (password 3333 required)*

Access : Hour settings / holidays

System is set with no vacation time. If you need to reduce fonctionnement time during vacation time, set the functioning time window as indicated in chapter V.3.4), and set the vacation days.

### V.4.b. Speed /pressure modification in LS and HS

#### V.4.b.1. *STANDARD (ECO) / DIVA [(5) chapter V.3.c]*

Access : ventilation Regul / Frequency control VAS 1/1 and 1/2 or frequency control VAR 1/1 et 1/2

You can modify the rotation speed of the unit in PV-1/2 (slow speed) and in HS-1/1 (normal speed) for each fan to set the airflows.

- To set the initial airflow (GV-1/1), force the system in normal speed with available terminals « Forced start HS » (bridge between 11 and 12 terminals).
- To set the initial airflow LS, force the system in slow speed with available terminals « Forced start LS » (bridge between 9 and 10 terminals).

#### V.4.b.2. *LOBBY [(5) chapter V.3.c]*

Access : ventilation Regul / Pressure control VAS 1/2 or Pressure control VAR 1/2

You can modify the constant pressure of the unit for each fan to set the airflows.

- To set the initial airflows LS, force the system in normal speed with available terminals « Forced start LS » (bridge between 9 and 10 terminals).

#### V.4.b.3. *MAC2®/QUATTRO® [(5) chapitre V.3.c]*

Access : ventilation Regul / Airflow control VAS 1/1 and 1/2 or Airflow control VAR 1/1 and 1/2

You can modify the rotation speed of the unit in PV-1/2 (slow speed) and in HS-1/1 (normal speed) for each fan to set the airflows.

- To set the initial airflow (GV-1/1), force the system in normal speed with available terminals « Forced start HS » (bridge between 11 and 12 terminals).
- To set the initial airflow LS, force the system in slow speed with available terminals « Forced start LS » (bridge between 9 and 10 terminals).

# OPERATING AND COMMISSIONING INSTRUCTIONS

### V.4.c. Temperature setpoint modification

[(8) chapter V.3.b]

Access : temperature Regul

Regulation is based on the temperature control of :

- Supply with external compensation (set in standard). Supply temperature setpoint follows outside temperature in compliance with RT 2012 norm.
- Extract
- Possibility to adjust the setpoint + or - when the unit runs in low speed. Think to change in + the setpoint adjustment if the unit is equipped by a cold battery.

### V.4.d. Forced stop of the unit or forced start LS or HS on the remote control

[(7) chapter V.3.a]

Access : running Mode / running Mode

You can stop (7) (**stop**) unit with CORRIGO controller or do a forced start LS (7) (**manual speed 1/2**) or HS (7) (**manual speed 1/1**). In standard unit works automatically with clocks (7) (**Auto**)



If unit do not work in automatic mode an alarm will start. Manual speed 1/1 and manual speed 1/2 modes must be used only for the commissioning and repair. An other setting will lead to a failure of the unit.

### V.4.e. Choice of language

[(10) chapter V.3]

Access: Starting screen / language choice

## V.5. Intermediate settings (service level)

**Type of regulation type setting, Night Cooling** parameters and **CO2 setpoint** require an access to the Configuration menu. You need the access right to the « Service » level. Follow the instructions below.



Enter **2222** with directional arrows and validate with OK. Press left arrow twice to reach the access of the menus. In case of mistake press C button twice and start again.

# OPERATING AND COMMISSIONING INSTRUCTIONS

### V.5.a. Menu configuration en accès service

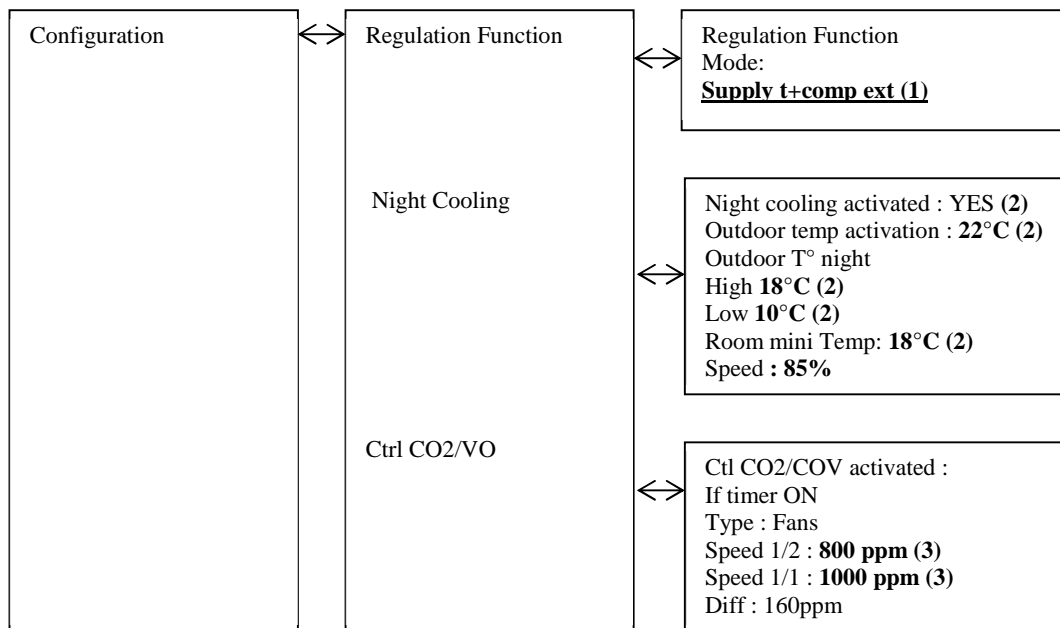

1. Regulation type choice (see chapter V.5.b.1)
2. Parameters modification Night Cooling (see chapter V.5.b.2)
3. CO2 set point modification (only in DIVA and QUATTRO) (see chapter V.5.b.3)

### V.6. Modification of the services parameters (password 2222)

#### V.6.a. Regulation mode of the unit

[(1) chapter V.5.a]

Access : Configuration / Regulation function.

Regulation type is set by default in the CORRIGO controller in outside compensation exhaust. You can also select return control mode.

**(ATTENTION, if you want to regulate following a room temperature, select the regulation mode« Ctrl extract » Any other mode will lead to the failure of the unit)**

#### V.6.b. Overventilation parameters

[(2) chapter V.5.a]

Access : Configuration / Night cooling

Night cooling speed is set in standard in 85%. You can modify it. You can also change the temperature of Night Cooling activation (outside temperature day...) and deactivate it.

#### V.6.c. CO2 setpoint for DIVA / QUATTRO option

[(3) Chapter V.5.a]

Access: Configuration / Ctrl CO2/COV

CO2 setpoint is set in standard: LS = 800ppm HS = 1000ppm. Unit will increase its speed proportionally to reach its maximum speed when CO2 will be at 1000ppm.

# OPERATING AND COMMISSIONING INSTRUCTIONS

### V.7. Administrator settings

Activation of the **communication**, **dehumidification** and **fire function** requires an access to Configuration menu in system level. You have to get the access rights to « Admin » level. Follow the instructions below:

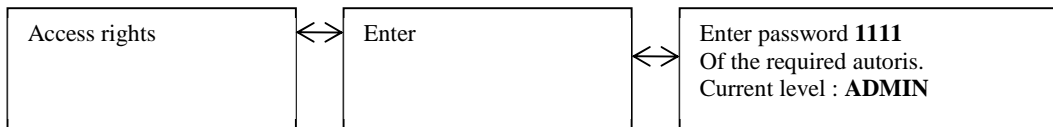

Enter **1111** with directionnal arrows and validate with OK button. Press left arrow twice to reach the menu. In case of mistake press C button twice and start again

#### V.7.a. Configuration menu with admin level access

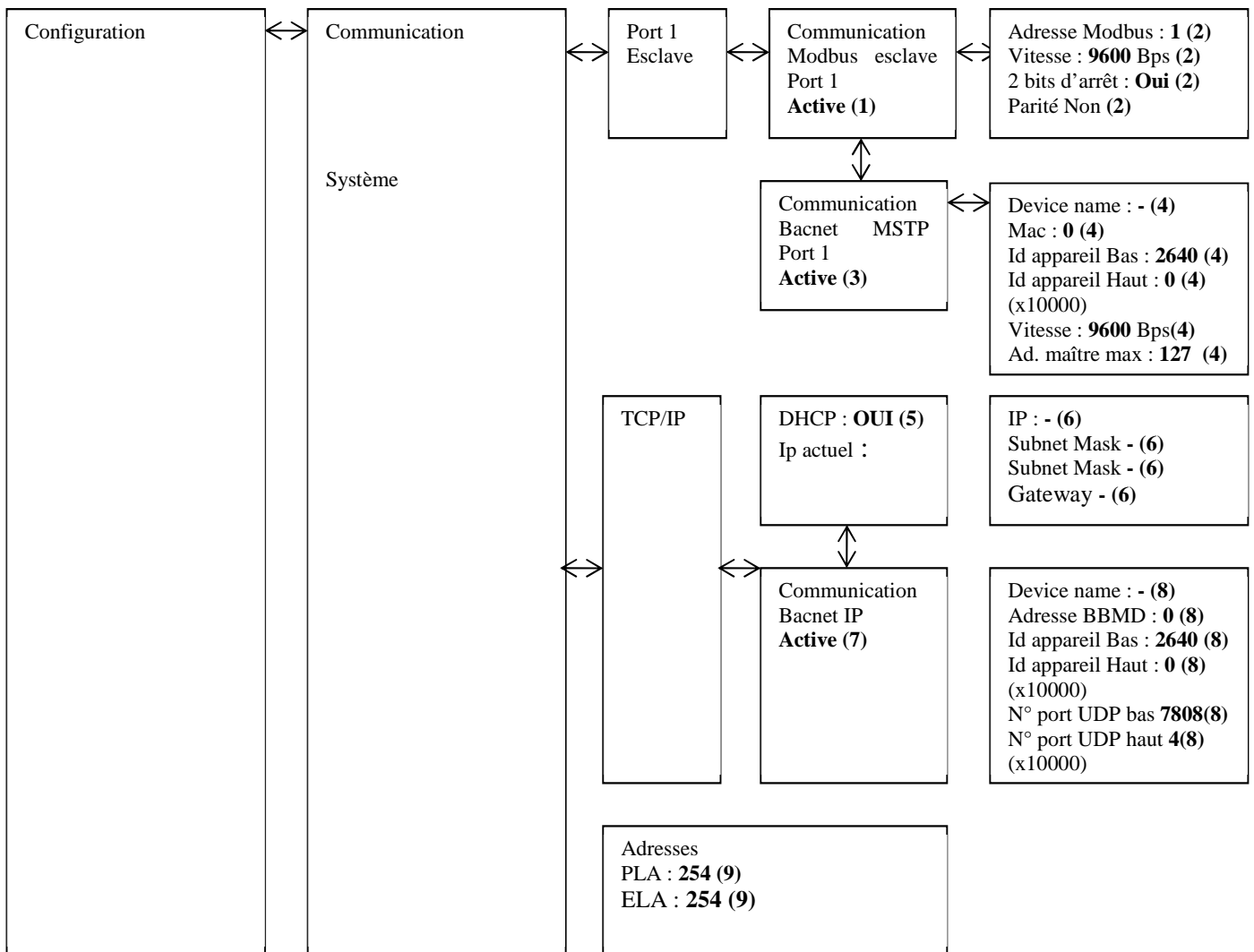

- 1 et 2 Activation MODBUS RS485 and settings (see chapter V.8)
- 3 et 4 Activation BACNET MSTP and settings (see chapter V.8)
- 5 et 6 Settings TCP/IP(see chapter V.8)
- 7 et 8 Activation du BACNET IP and settings (see chapter V.8)
- 9 Adressage Repetiteur (voir chapitre V.8)

# OPERATING AND COMMISSIONING INSTRUCTIONS

## V.8. Modification of the service parameters

### V.8.a. MODBUS

You will find the simplified MODBUS at the end of the instructions and commissioning manual.

Access : Configuration / Communication

**MODBUS TCP/IP** is activate in standard in DHCP. Possibility to know DHCP adress or set IP fixe [(5)(6) chapter V.7], Modbus Port = 502 / Device ID = 255

Le **MODBUS RS 485** must be activate [(1) chapitre V.7]. Possibility to set speed, parity, stop bits... [(2) chapter V.7].

#### Modbus Type

1 = Coil status register (Modus fonction 1, 5 et 15)

2 = Input status register (Modus fonction 2)

3 = Holding register (Modus fonction 3, 6 et 16)

4 = Input resister (Modus fonction 4)

#### Supported Modbus functions

Read Coils (1)

Read discrete input (2)

Read Holding registers (3)

Read Input registers (4)

Write single Coils (5)

Write single register (6)

Write multiple Coils (15)

Write multiple register (16)

#### EXOL Type

R = Real (-3.3E38 – 3.3E38)

I = Integer (-32768 – 32767)

X = Index (0 – 255)

L = Logic (0/1)

#### Transmission mode

Controller is set in RTU mode

A maximum of 47 registers can be read in one message

### V.8.b. Repetitors and EXO communication

[(3) chapitre V.7]

Access : Configuration / System

An instruction and commissioning manual is delivered with repetitor. In the case of you have several CORRIGO connected to to the same remote control ( up to 6 CORRIGO), you have to modify the address PLA / ELA of each CORRIGO. In this case you will need a different address on each CORRIGO and enter them in the repetitor. Follow the instructions in the commissioning manual for the setting and use.

### V.8.c. WEB Communication

You have the possibility to communicate via TCP/IP WEB in language. In this case the device is delivered with Web page and regulator set in DHCP.

Possibility to know DHCP adress or set IP fixe [(5)(6) chapter V.7], or via E-tool software <http://www.regin.se>

# OPERATING AND COMMISSIONING INSTRUCTIONS

## V.8.d. BACNET IP Communication with BASC type

You will find the simplified BACNET at the end of the instructions and commissioning manual.

Accès : Configuration / Communication

**BACNET IP** must be activate [(7) chapter V.7]. Possibility to know DHCP adress or set IP fixe [(5)(6) chapter V.7]. Possibility to set ID / N°port... [(8) chapter V.7].

**BACNET MSTP** must be activate [(3) chapter V.7]. Possibility to set speed, ID, adress... [(4) chapter V.7]. Speed = 9600 / MAC adress = 0 / Device ID = 2640 / Max master = 127

BACnet Type

10XXX = Read and write Binary

20XXX = Read binary

30XXX = Read and write analogue

40XXX = Read analogue

30XXX = Read and write multistate

40XXX = Read multistate

(XXX = MODBUS Adress)

AV = Analogue Value

BV = Binary Value

MSV = Multistate value

BMMD Adress : The BBMD adress is used for discovering devices taht are attached to different BACnet/IP subnets and separates by an IP router. The address is entered as host:host can be the host's name if DNS ins configures. If DNS is not configured, the host address should be entered in the format xxx.xxx.xxx.xxx followed by the port number (default settings 47808)

MAC : The MAC address of the device. This need to be unique only to the subnet.

Device ID : The ID of a device, used to identify it on the BACnet network. This number cannot be duplicated anywhere on the BACnet network and must therefore be unique. To set an ID value of 34600, the low number would be set to 4600 and the high number to 3

For more information see CORRIGO Pics via <http://www.regin.se>

## V.8.e. Communication LON (si CORRIGO avec option LON)

Set the LON function as below:

In Configuration menu/ Communication / Fonction port 2 = Activate the Port 2 function in extension unit.

Go on the right and activate extension unit. 1 en CORRIGO E28 LON

Button for the PIN service is at the back of the regulator.

Communication table is on <http://www.regincontrols.com>

## V.8.f. Fire function activation

### Setting of the Paramétrage de l'entrée

Access : Configuration / Input Output / DI / DI8

Déclarer l'input DI8 en « Al fire » « NO »

### Paramétrage de la fonction

Access : Configuration / Fire function

Choose the required mode when activating the fire function

« Stop » : Complete stop of the unit

«Continuous operation »: Start or keeping of the unit in HS. Fire function will have priority on all others alarms.

«Normal operation»: keeps the unit in the same parameters chosen on site (stop/LS/HS)

« Exhaust fan only »: Start or keep in HS the exhaust fan (return is stopped)

« Return fan only »: Start or keeps in HS the return fan (exhaust stopped)

### Alarm setting

Access: Configuration / alarm configuration

Enter alarm number « 10 » go on the right and enter in priority « C alarm C » « Active »

# OPERATING AND COMMISSIONING INSTRUCTIONS

*V.8.g. Activation of the function dehumidification*

**Input settings**

Access : Configuration / Input Output / UI / UI4  
Declare UI4 input in « Ambiance Humidity »

**Function setting**

Access: Configuration / Ctrl Humidity  
Choose « Dehumidification »

**Setpoint setting**

Access: Humidity Regul  
Enter the required setpoint

## VI. REPAIR

### VI.1. Différent type of defaults

A specific screen appear if you have an alarm (see ED-TOUCH manual). Celui -ci sera de classe A, ou C (voir détail ci-dessous)

Type of default:

C : Default do not stop the ventilation system and automatically disappears when a solution is found.

To solve a default press the alarm button (red), « delete » then « enter » the default with directional arrows and press OK button

Attention : do not « block »

Description	Cause
CORRIGO screen do not light up	- Unit is not powered correctly (LED P/B of CORRIGO switched off) - To light up the screen, press a button (backlit). - Command fuse is disused
Fans do not start	- Clocks are on 0 - No external start order - External stop - Active alarm
Remote control do not run or gives wrong values	Remote control further than 100m Repetitor is not connected correctly

### VI.2. List of alarms

n°	View	Description	Type	Tempo	Cause
1	Malfunction supply air fan	(UDI2 must be closed « Fer »if fan runs) Or UAI2 must be higher than 30Pa if fan runs )	A	30s (120s for LOBBY)	<ol style="list-style-type: none"> <li>1. Pressure switch is wrongly connected (pressure switch must be set in 30Pa).</li> <li>2. Pressure on the transmitter is lower to 30Pa. (LOBBY®) (contact us)</li> <li>3. Motor is disused</li> <li>4. Thermic protection motor is activated</li> <li>5. Contrôler le raccordement des tubes crystal (chapitre IV.8 et IV.9)</li> <li>6. Présence d'eau dans le tube crystal</li> <li>7. 0-10V motor is inverted</li> </ol>
2	Malfunction extract air fan	(UDI3 must be closed « Fer »if fan runs) Or UAI3 must be higher than 30Pa if fan runs)	A	30s (120s for LOBBY)	<ol style="list-style-type: none"> <li>1. Pressure switch is wrongly connected (pressure switch must be set in 30Pa).</li> <li>2. Pressure on the transmitter is lower to 30Pa. (LOBBY®) (contact us)</li> <li>3. Motor is disused</li> <li>4. Thermic protection motor is activated</li> <li>5. Control the connection of the crystal tubes (chapter</li> </ol>



## OPERATING AND COMMISSIONING INSTRUCTIONS

					IV.8 and IV.9 6. Water in the crystal tubes 7. 0-10V motor is inverted
6	Filter guard 1	DI1 must be open « Ouv » if there is no default	C	5s	1. Filters are dirty 2. Filters pressure switches are wrongly connected (Pressure switches must be set on 150 Pa for G4 200Pa for F7). 8. Control the connection of the crystal tubes (chapter IV.8)
8	External frost guard	Ext DI3 must be closed « Fer » if there is not default	C	120s	1. THA thermostat is not set on 5°C 2. THA thermostat s disused 3. Circulating pump is disused 4. 3 ways valve 3 is wrongly connected, hydraulically or is disused
15	High supply air temp	Ext AI1 is mounted higher than 50°C	A	30s	1. Exhaust temperature is higher than 50°C 2. Temperature setting is too high 3. Exhaust fan is stopped (vent AS Default) when hot battery is in full capacity.
23	Electric heating is overheated	Ext DI3 must be closed « Fer » if there is no default	A	5s	1. Safety thermostat THS is activated. To reset THS, push on the rearmament on the electric battery 2. Power cut 3. Exhaust fan is stopped (vent AS Default) when electric battery is in full capacity
27	Sensor error outdoor temp	Control the value Ext AI2	A	5s	Outside temperature sensor SEG is disused .Outside temperature sensor SEG is wrongly connected (see chapter IV.3)
31	Supply air fan control error	Difference higher than 50Pa between exhaust setpoint and pressure on Ext UAI1	C	30min	The network of blowing do not correspond to the fan or to the setpoint. Filter is dirty
32	Extract air fan control error	Difference higher than 50Pa between exhaust setpoint and pressure on Ext UAI2	C	30min	Return network do not correspond to the fan or to the setpoint. Filter is dirty
35	Manual	Runs in manual mode	C	5s	Default à titre indicatif (le centrale est passée à l'arrêt en PV ou en GV directement sur l'afficheur (voir (7) chapitre V.3.a)
36 à 44	... in Manual mode	Functions are modified in manual mode	C	5s	In the Auto Manual menu everything must be in Auto.
48	Internal battery error	Error battery intern	A	5s	Intern battery of the CORRIGO is disused Change the battery quickly in order to not loose programm. See chapter VII.2
49	Sensor error supply air temp	Control the Value on Ext AI1	A	5s	Outside temperature sensor SSG is disused Outside temperature sensor SSG is wrongly connected (see chapter V.3.a)
50	Sensor error extract air temp	Contrôler la valeur sur Ext AI3	A	5s	Outside temperature sensor SRG is disused Outside temperature sensor SRG is wrongly connected (see chapter V.3.a)
55	Sensor error pressure VAS	Control the value on Ext UAI1	A	5s	0-10V signal is inverted Pressure transmittor on fresh air is in short-circuit

## OPERATING AND COMMISSIONING INSTRUCTIONS

56	Sensor error extract VAR	Control the value on Ext UAI2	A	5s	0-10V signal is inverted Pressure transmittor on intake air is short circuited
59	CO2 sensor error	Control the Value on Ext AI4	A	5s	0-10V signal is inverted CO2 transmittor is in short-circuit
85	... in manual mode	Functions are modified in manual mode	A	5s	In Manuel Auto menu everything must be in Auto.
86	Time for service	Regular visit	C	5s	See chapter VI.3
87	... in manual mode	Functions are modified in manual mode	C	5s	In Manuel Auto menu everything must be in Auto.

### **VI.3. Acknowledge the default « timer service »**

These settings require an access to the setting menu. You need the access rights to “service” level. Follow the instructions below.



Enter the code **2222** with directional arrows then press the OK button. Press the left arrow twice to reach the menus. In case of mistake press C button twice and start again.

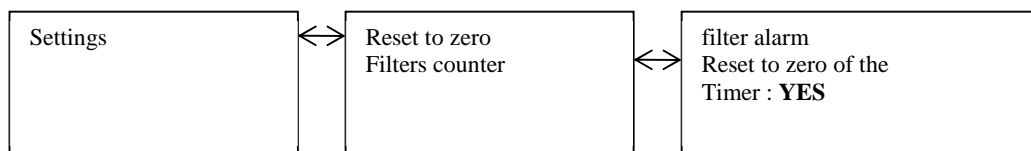

An alarm occurs every 6 months to remind the maintenance visit. Enter YES to reset the counter to zero

## **VII. MAINTENANCE**

### **VII.1. Obligatory maintenance**

#### Outside the unit

Check the ducts, flexible sleeves, anti-vibrating plots; replace them if necessary. Check that all elements connected to the unit do not give any vibration to the unit.

#### Unit and Regulation

Check connection every year

#### Filtration

Do not damage the filters

Classification	Max pressure drop	Efficiency of the filtration	Reference	Washing* (Water + light detergent )	Aspiration* Exhaust*
----------------	-------------------	------------------------------	-----------	--	-------------------------

### OPERATING AND COMMISSIONING INSTRUCTIONS

		EUROVENT			
Gravimetric	150Pa	EU4	G4	Limited (1 to 4 times)	YES
Opacimetric	200Pa	EU7	F7	NO	

Componants	Periodicity of the cleaning			
	1 MONTH	3 MONTHS	6 MONTHS	12 MONTHS
<i>Filtration</i>	Blowing (for the G4filters)	Cleaning (for the G4filters)	Washing (for the G4filters )	Replacement Of the filters if needed

Rotative exchanger (12 month)

Check belt and change it if necessary

#### VII.2. Battery replacement

When low battery alarm starts and red LED is lighting, this indicates that the safety battery for the safeguard of the memory and clock is too low. Follow the instructions below to change them. A condenser keeps the safeguard and let the clock running for 10 minutes left after power cut. If the replacement of the battery takes less than 10 minutes, you will not have to reset the program and clock will work normally.

Replacement battery is a CR2032 type



Press the clips on each sides of the box with a little screwdriver to open the the top of the box.

Location of the battery

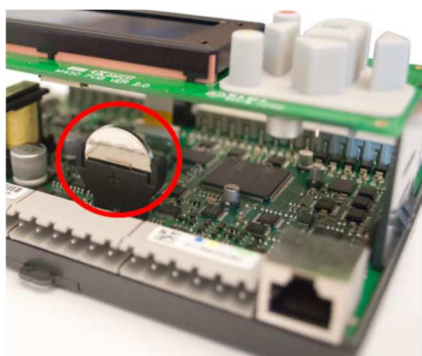

Take the battery and remove it softly .

Press firmly the new battery in the support. Note : Attention to the direction and polarity of the battery.

**OPERATING AND COMMISSIONING INSTRUCTIONS**

**VIII. ANNEXES**

**VIII.1. Control scheme**

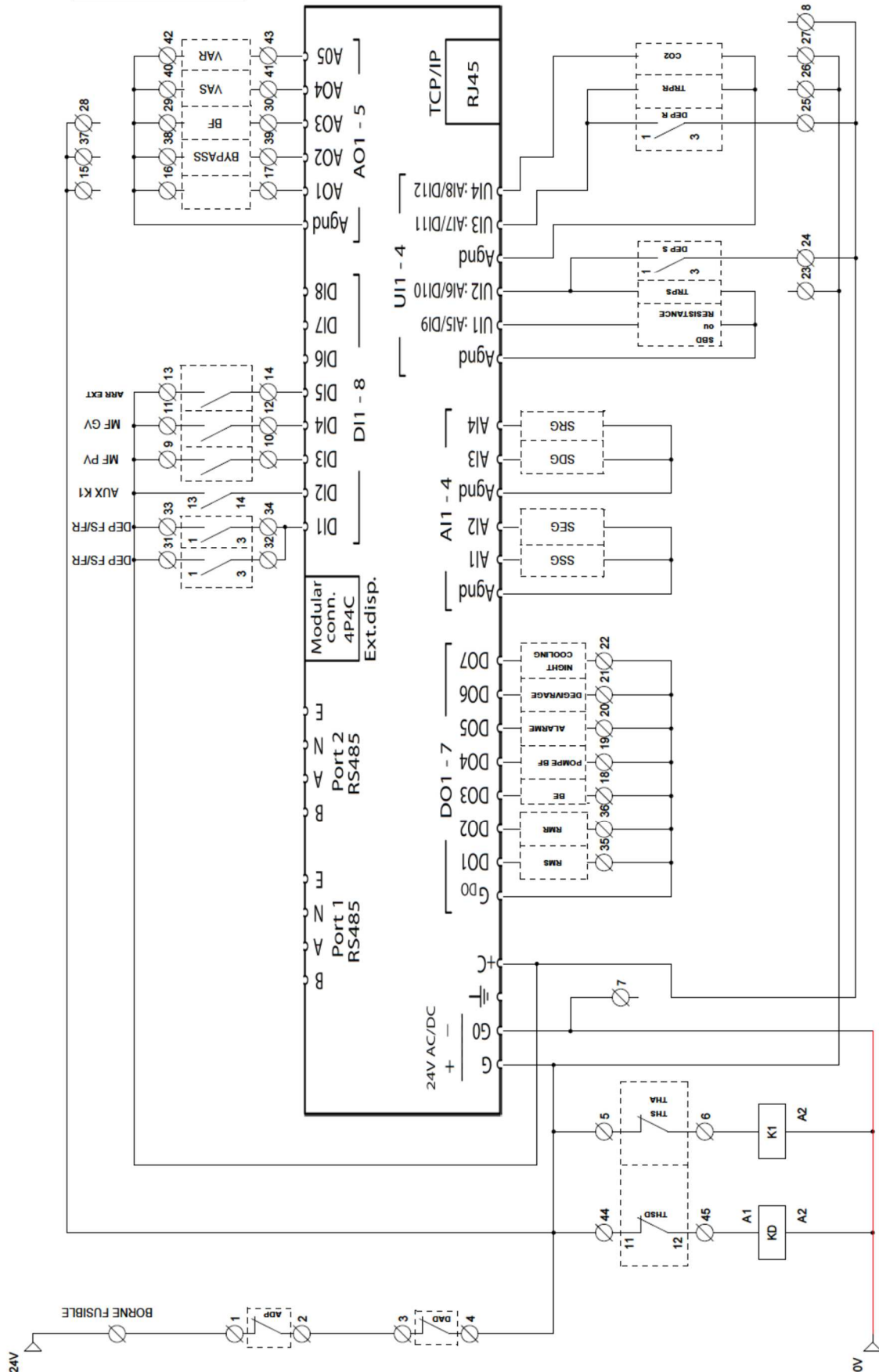

# OPERATING AND COMMISSIONING INSTRUCTIONS

### VIII.2. Motor wiring SILVERTOP 06-08

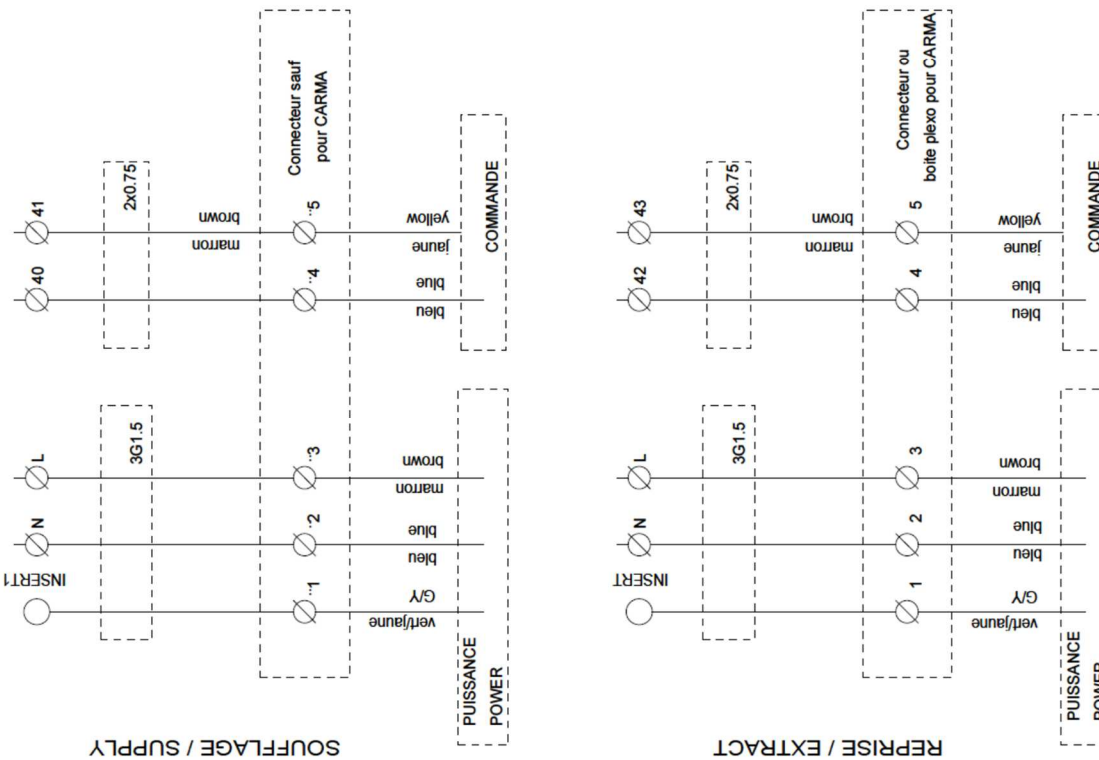
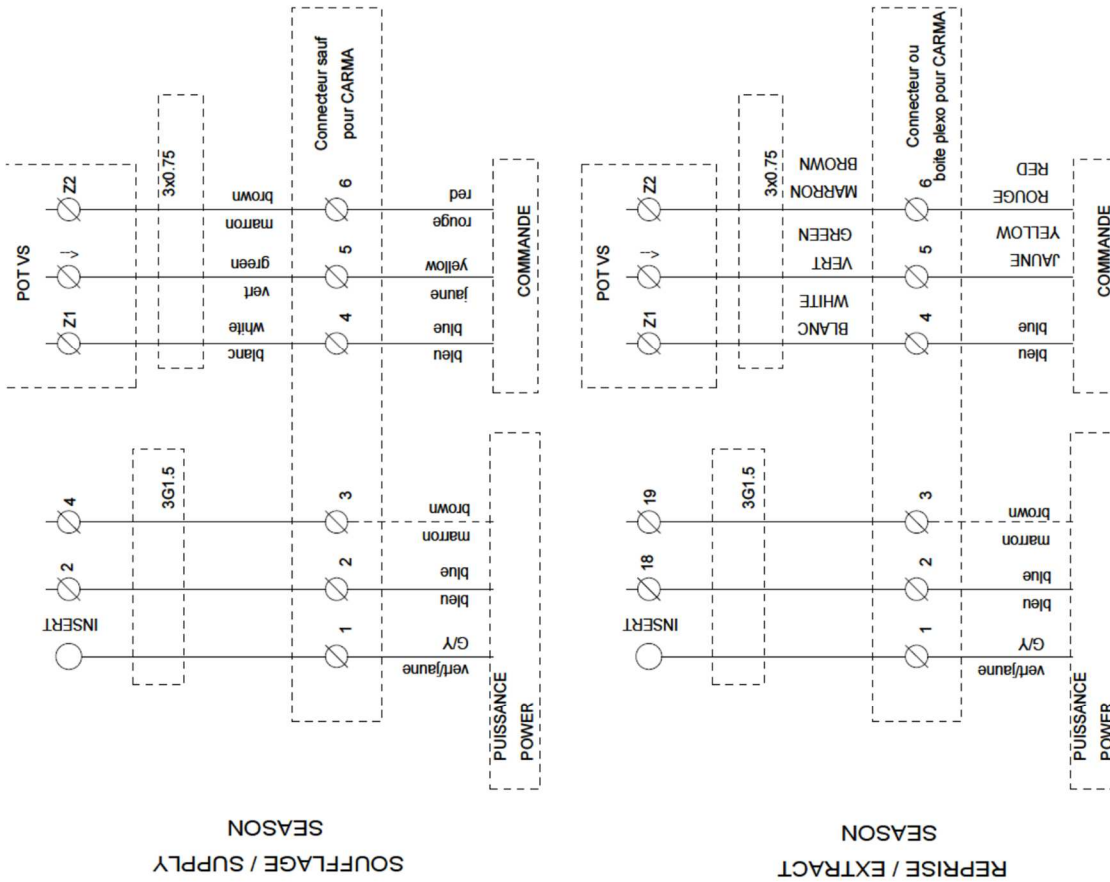

## OPERATING AND COMMISSIONING INSTRUCTIONS

### VIII.3. Moto wiring SILVERTOP 15-52

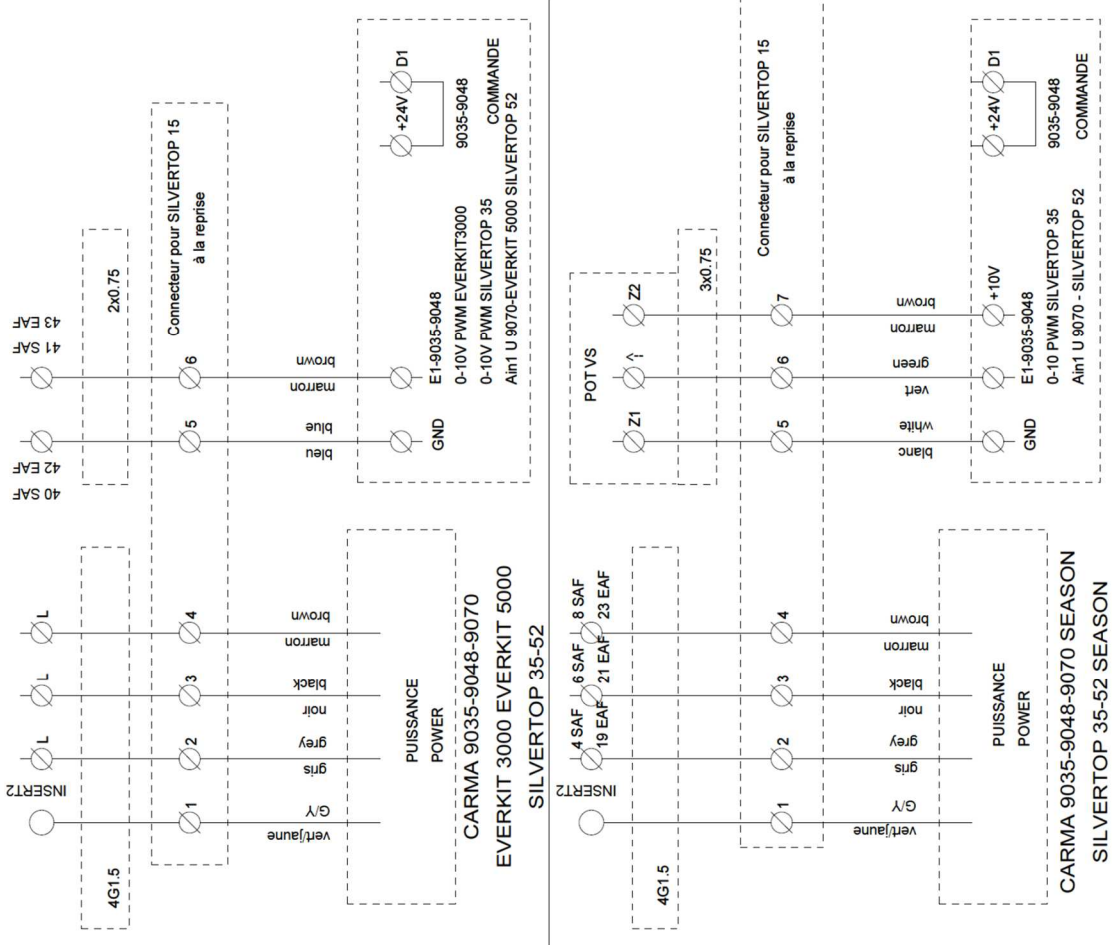

Ce document est notre propriété, il ne peut être reproduit sans notre accord écrit

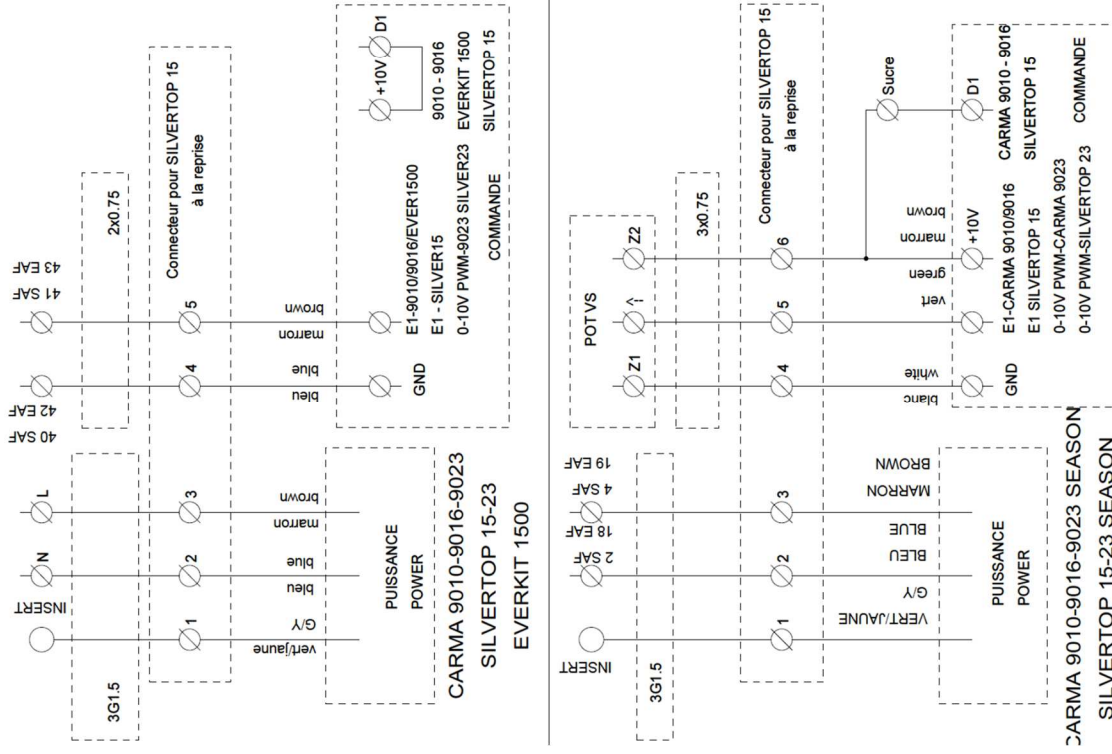

**OPERATING AND COMMISSIONING INSTRUCTIONS**

**VIII.4. Curves**

SILVERTOP 06

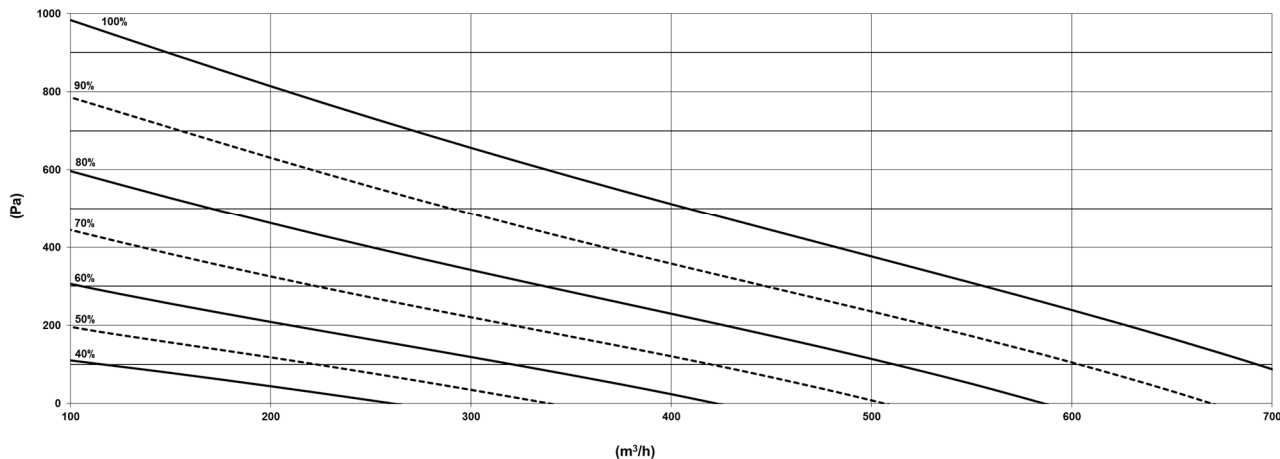

SILVERTOP 08

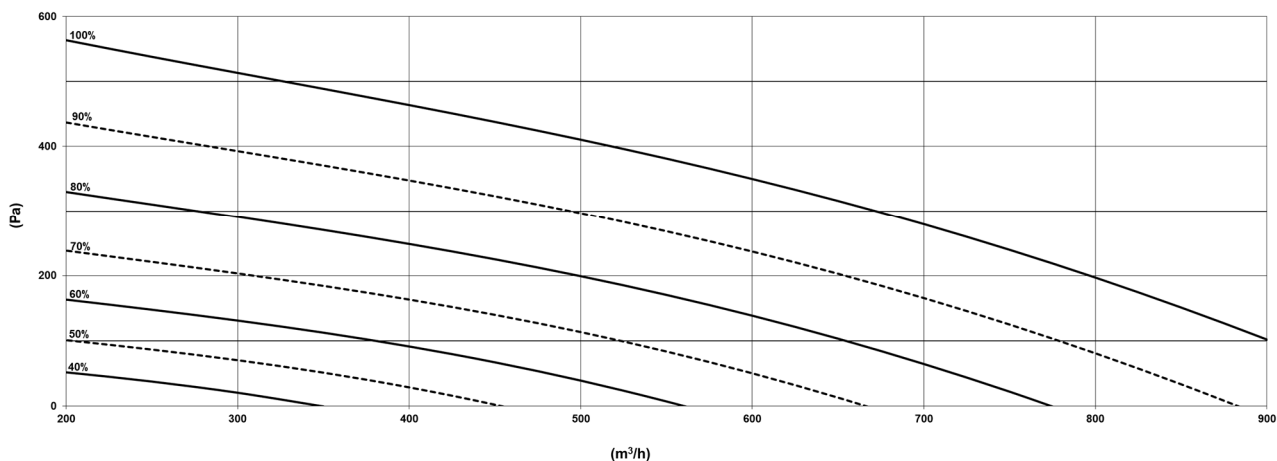

SILVERTOP 15

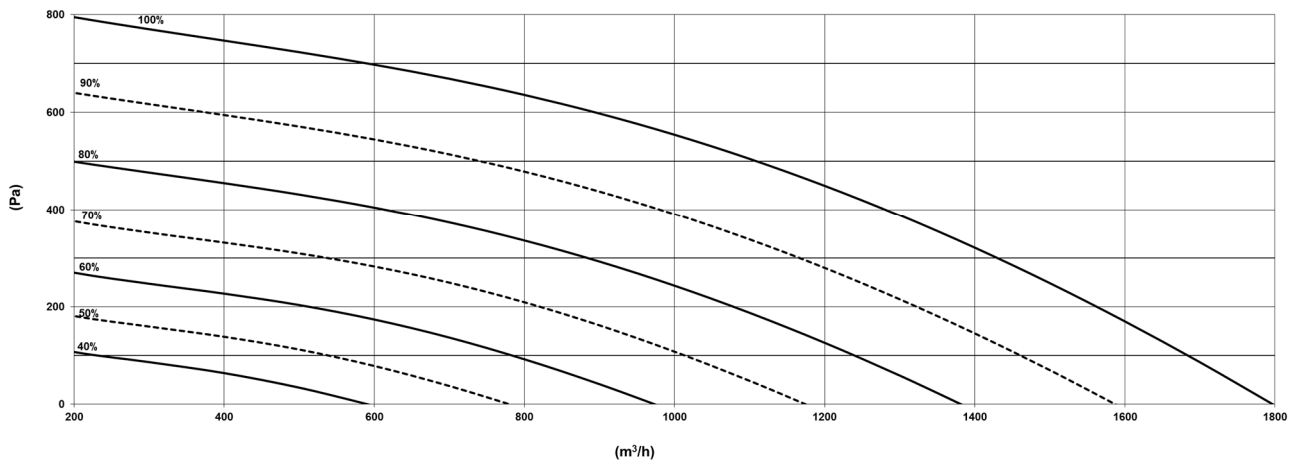

**OPERATING AND COMMISSIONING INSTRUCTIONS**

SILVERTOP 23

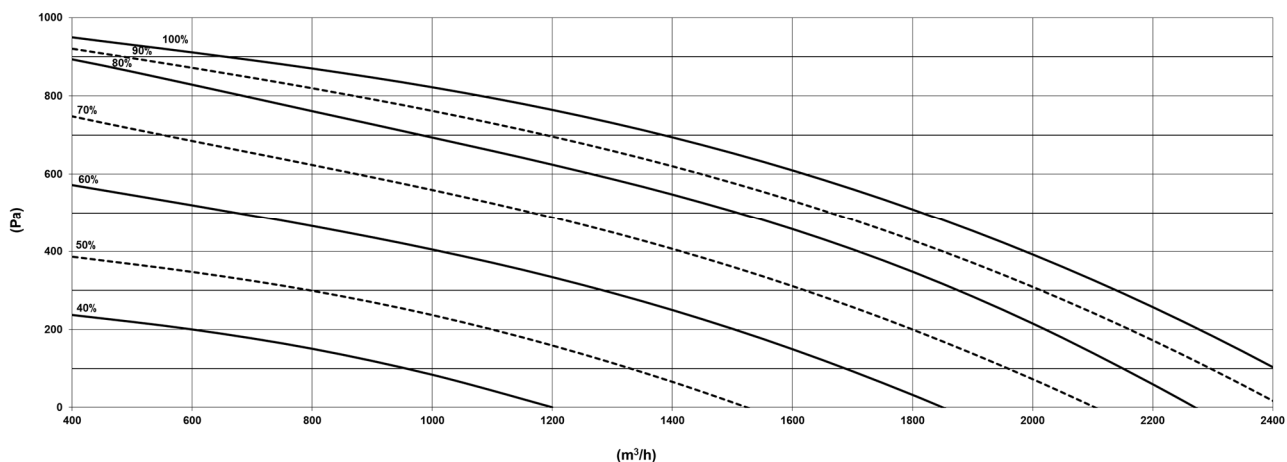

SILVERTOP 35

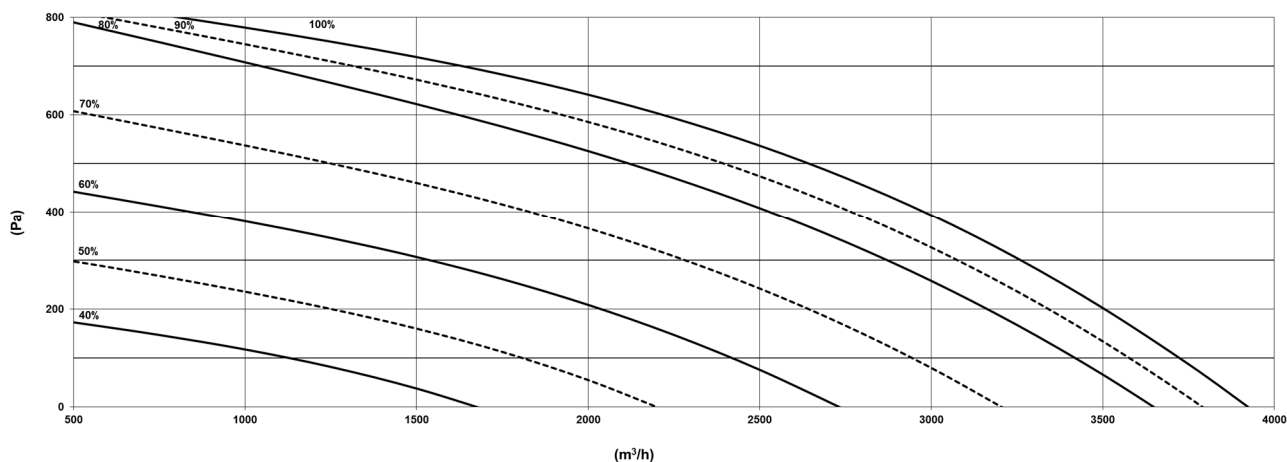

SILVERTOP 52

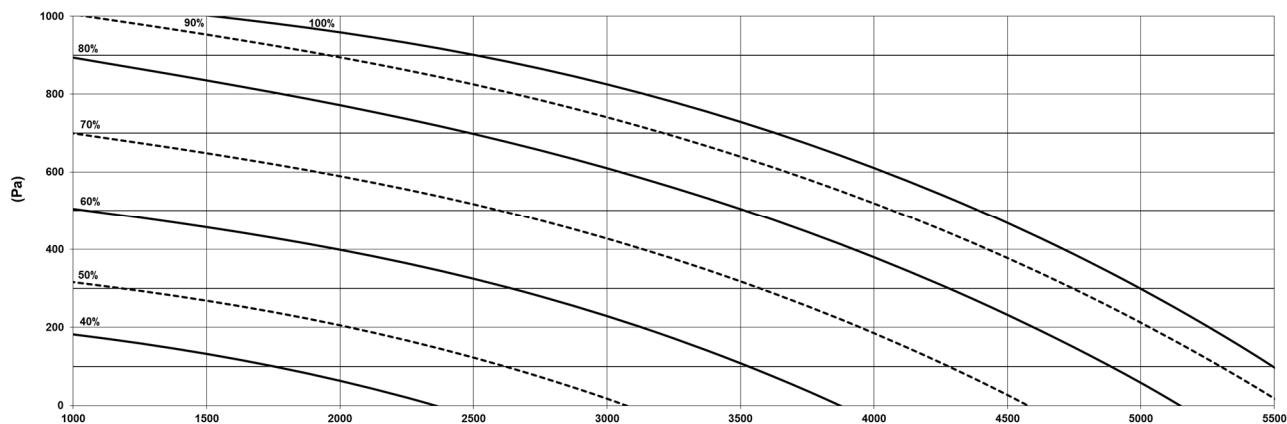



# OPERATING AND COMMISSIONING INSTRUCTIONS

**VIII.1. Table MODBUS et BACNET**

## INPUT REGISTER

Fonction	Description	Exo type	Modbus Adresse	Bacnet Adresse	Défaut value
Unit XXXXX	Modbus : 0= stop 1= start 2= start Slow speed 3= start maxi speed 4= start normal speed 5= In operation 8= CO2 fonctionning 9= Night cooling 11= stopped  BACNET : 1= stop 2= start 3= start Slow speed 4= start speed maxi 5= start normal speed 6= In operation 9= CO2 fonctionning 10= Night cooling 12= stopped	X	3	MSV, 40003	
Outdoor Temperature		R	1	AV, 40001	
Operating time of the supply fan		R	4	AV, 40004	
Operating time of the extract fan		R	5	AV, 40005	
Supply air Temperature		R	7	AV, 40007	
Extract Temperature		R	9	AV, 40009	
SAF pressure	LOBBY EC	R	13	AV, 40013	
EAF pressure	LOBBY EC	R	14	AV, 40014	
Supply constant air flow	MAC2®/QUATTRO®	R	15	AV,40015	
Extract constant air flow	MAC2®/QUATTRO®	R	16	AV,40016	
CO2	DIVA® QUATTRO	R	17	AV,40017	
Humidity		R	23	AV,40023	
Analog output	0-10V Heating (water only)	R	54		
Analog output	0-10V Exchanger	R	55		
Analog output	0-10V Cooling	R	56		
Analog output	0-10V SAF	R	57		
Analog output	0-10V EAF	R	58		

# OPERATING AND COMMISSIONING INSTRUCTIONS

## HOLDING REGISTER

Fonction	Description	Exo type	Modbus Adresse	Bacnet Adresse	Défaut value
Supply setpoint	Set in constant supply	R	1	AV, 30001	18
Supply setpoint	Set in constant supply comp ext for T°C out -20°C	R	10		25
Supply setpoint	Set in constant supply comp ext for T°C out de -15°C	R	11		24
Supply setpoint	Set in constant supply comp ext for T°C out de -10°C	R	12		23
Supply setpoint	Set in constant supply comp ext for T°C out de -5°C	R	13		23
Supply setpoint	Set in constant supply comp ext for T°C out de -0°C	R	14		22
Supply setpoint	Set in constant supply comp ext for T°C out de +5°C	R	15		20
Supply setpoint	Set in constant supply comp ext for T°C out de +10°C	R	16		18
Supply setpoint	Set in constant supply comp ext for T°C out de +15°C	R	17		18
Return setpoint	Set in return control	R	18	AV, 30018	21
speed supply HS setpoint	In % for ECO and DIVA	R	424		70
speed supply LS setpoint	In % for ECO and DIVA	R	425		50
speed return HS setpoint	In % for ECO and DIVA	R	426		70
speed return LS setpoint	In % for ECO and DIVA	R	427		50
pressure soufflage setpoint	In Pa for LOBBY	R	25	AV, 30025	150
pressure reprise setpoint	In Pa for LOBBY	R	27	AV, 30027	150
Airflow supply HS setpoint	In m3/h for MAC2® and QUATTRO®	R	28	AV,30028	xxx
Airflow supply LS setpoint	In m3/h for MAC2® and QUATTRO®	R	29	AV,30029	xxx
Airflow return HS setpoint	In m3/h for MAC2® and QUATTRO®	R	30	AV,30030	xxx
Airflow return LS setpoint	In m3/h for MAC2® and QUATTRO®	R	31	AV,30031	xxx
Forced Functionning mode of the unit	MODBUS 0= Manual stop 1= Manual slow speed 2= Vitesse normale manuelle 3= Auto BACNET 1= manual stop 2= Manual slow speed 3= Normal manual speed 4= Auto	X	368	MSV,30368	xx:xx



# OPERATING AND COMMISSIONING INSTRUCTIONS
