

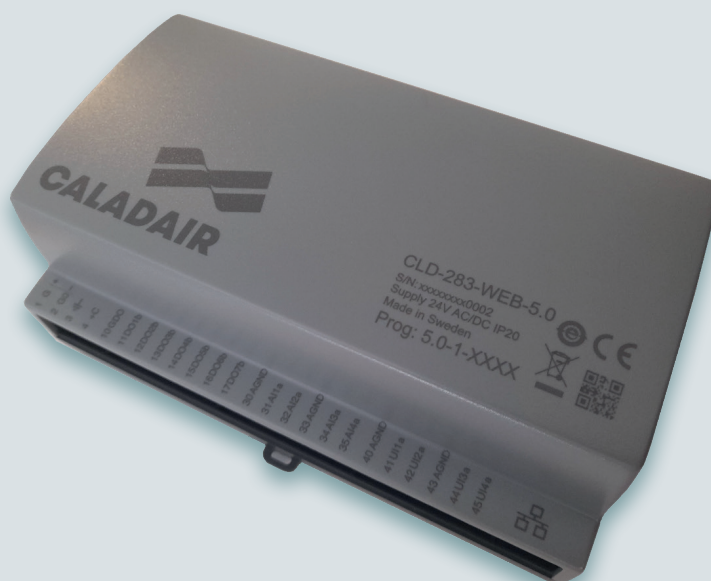

Zehnder EASY 5.0

Installation, Service and User Manual

always the best climate



Contents

1.	Physical presentation of the PG 5.0 touchscreen	5
2.	Physical presentation of the CLD-283 controller	6
3.	Electrical connection of CLD-283 controller/PG 5.0 DISPLAY	8
4.	Zehnder Easy 5.0 and Zehnder EDT2 remote touchscreen controls (Optional)	8
4.1.	Zehnder Easy 5.0 wall-mounted touchscreen master control	8
4.2.	Zehnder EDT2 wall-mounted touchscreen user control	8
5.	Definition of thermal sequences	9
5.1.	General	9
5.2.	Demand and need for heating	10
5.3.	Demand and need for cooling	10
5.4.	Demand and need for heat recovery	10
6.	Initialisation of thermal sequences at start-up	11
7.	Start-up sequence	11
8.	Shutdown sequence	12
9.	Night cooling function	12
10.	Anti-icing function by reducing the supply air volume	14
11.	Anti-fire function	16
11.1.	General information on the function and its possible configuration	16
11.2.	Fire alarm (N°58)	17
12.	Commissioning procedure	18
13.	Time period settings	19
13.1.	General	19
13.2.	Priorities for time periods and external controls	20
13.3.	Holiday calendar	21
13.4.	Recommendations for time period settings in the LOBBY version	22
13.5.	Recommendations for time period settings in the DIVA and QUATTRO versions	22
13.6.	Recommendations for time period settings in the ECO et MAC2 versions	23
14.	Maintenance and fault diagnosis	23
14.1.	General	23
14.2.	Checks prior to any diagnosis	24
14.3.	Simplified diagnosis	24
14.4.	Advanced diagnosis	24
14.4.1.	Checking an active BMS	25
14.4.2.	Input checks	25
14.4.3.	Output checks	26
14.4.4.	Manual control of outputs	27
15.	Alarms	28
15.1.	General	28
15.2.	Alarm class	28
15.3.	Alarm action	28
15.4.	Alarm time limit and time unit	29
15.5.	Alarm threshold	29
15.6.	Alarm state (or status)	29
15.7.	Active alarms	29
15.8.	Alarm history	30
15.9.	Alarm maintenance (filters)	30
15.10.	Alarm and fault table	31
15.11.	Fan feedback and difference thresholds	36
15.12.	Frost protection alarm details	37
16.	BMS communication	37
16.1.	General	37
16.2.	Modbus RTU RS485 communication	38
16.3.	Modbus TCP communication	39
16.4.	Bacnet MS/TP and Bacnet IP communication	40
16.5.	IP configuration (DHCP)	42
16.6.	Modbus and BACnet exchange tables	42

Contents

16.6.1.	Machine status	43
16.6.2.	Guidelines	44
16.6.3.	Faults and alarms	46
17.	On-board web server	48
18.	Temperature control modes	48
18.1.	Selection of temperature control mode	49
18.2.	Constant supply air temperature	50
18.3.	Supply air temperature in relation to the outdoor temperature (supply air law)	51
18.4.	Constant return air temperature	51
18.5.	Return air temperature in relation to the outdoor temperature (return air law)	52
19.	Fan controller modes	52
19.1.	General	53
19.2.	ECO controller	53
19.3.	DIVA controller	54
19.4.	LOBBY controller	55
19.5.	MAC2 controller	56
19.6.	QUATTRO controller	57
20.	Control of the electric air heater (BE)	58
20.1.	Modulation of thermal output	58
20.2.	Overheating protection via safety thermostat THS	59
21.	Control of the hot water heating coil	60
21.1.	Modulation of thermal output	60
21.2.	Frost protection thermostat (THA)	60
21.3.	Thermal output	60
22.	Control of the hot water pump	61
23	Control of the cold water coil	61
23.1.	Modulation of thermal output	61
23.2.	Frost protection	62
23.3.	Thermal output	62
24.	Control of the cold water pump	62
25.	Control of the electric fresh air preheating coil	62
26.	Control of the rotary heat exchanger	64
26.1.	General	64
26.2.	Modulation of the heat recovery rate	64
26.3.	Rotary exchanger feedback	64
27.	Control of the plate heat exchanger	65
27.1.	General	65
27.2.	Modulation of the heat recovery rate	66
27.3.	Protection against icing of the plate heat exchanger	66
28.	LOBBY pressure transducers	68
29.	MAC2 / QUATTRO pressure transducers	69
30.	ECO / DIVA fan operating control pressure switches	70
31.	PT1000 temperature sensor	71
32.	CO₂ sensor	72
33.	Help with setting PID parameters	73
34.	Control of the output voltage of the digital outputs DO	75
35.	Presentation of the "PG 5.0" touchscreen	76
35.1.	Technical specifications	76
35.2.	Software version and regulatory compliance	76
35.3.	PG 5.0 touchscreen basic settings	77
35.4.	Access level	77
35.5.	Dashboard and home pages	77
35.5.1.	Home page 1	77
35.5.2.	Home page 2	78
35.5.3.	Home page 3	79
35.6.	Navigation and menu access	79

Legal regulations

All rights reserved.

This manual has been compiled with the utmost care. Nevertheless, the publisher accepts no liability for damage caused by missing or incorrect details in this operating manual. We reserve the right at any time and without prior notification to change the content of these instructions in part or as a whole.

The information contained in these documents is the property of Zehnder Group. Any form of publication, whether in whole or in part, requires the written approval of Zehnder Group. In-house duplication, designated for the evaluation of the product or for proper use, is permitted and not subject to approval.

Zehnder manufacturer's warranty

The current device terms are available online

(<https://www.caladair.com/en/espace-client/media/sales-terms-and-conditions>).

Hard copies can be obtained via our established sales channels.

Trademarks

All trademarks are recognised, even if they are not separately labelled. A missing label does not mean that an article or sign is free of trademark rights.

© 2021 Zehnder Group

SAFETY AND ENVIRONMENTAL GUIDELINES

In accordance with the regulations in force, the installation and maintenance of the machine must only be carried out by technically qualified personnel authorised for this type of appliance and work.

Use the necessary Personal Protective Equipment to avoid injury related to electrical, mechanical (injuries from contact with metal sheets, sharp edges, etc.) and acoustic hazards.

Do not use the appliance for any purpose other than that for which it is designed. This appliance may only be used to convey air free of hazardous compounds, construction dust, etc.

Move the appliance as described in the chapter on handling.

Grounding must be done in accordance with the applicable standards. Never switch on an ungrounded appliance.

Before carrying out any work, make sure that the unit is switched off and wait for the moving parts to stop completely before opening the doors (fans).

During operation, inspection panels, doors and hatches must always be fitted and closed.

The appliance can only be switched on and off via the proximity switch.

The safety and control equipment must not be removed, short-circuited or disabled.

The installation must comply with fire safety regulations.

All waste produced must be handled in accordance with the regulations in force.

It is the responsibility of the installer of the equipment to ensure compliance with the regulations concerning noise emissions inside the building and to adapt the installation and site conditions if necessary.

We accept no liability for damage resulting from misuse of the equipment, unauthorised repair or modification or failure to observe these instructions.

1. Physical presentation of the PG 5.0 touchscreen



The PG 5.0 touchscreen replaces the ED9200 display.

The 4.3" touch technology with a display of 65,000 colours allows high-quality images and advanced features that facilitate human-machine interaction and make navigation between the different screens easier.

It is protected against the weather and UV rays thanks to its IP65 protection rating and a swivel cap attached directly to the faceplate of the machine.

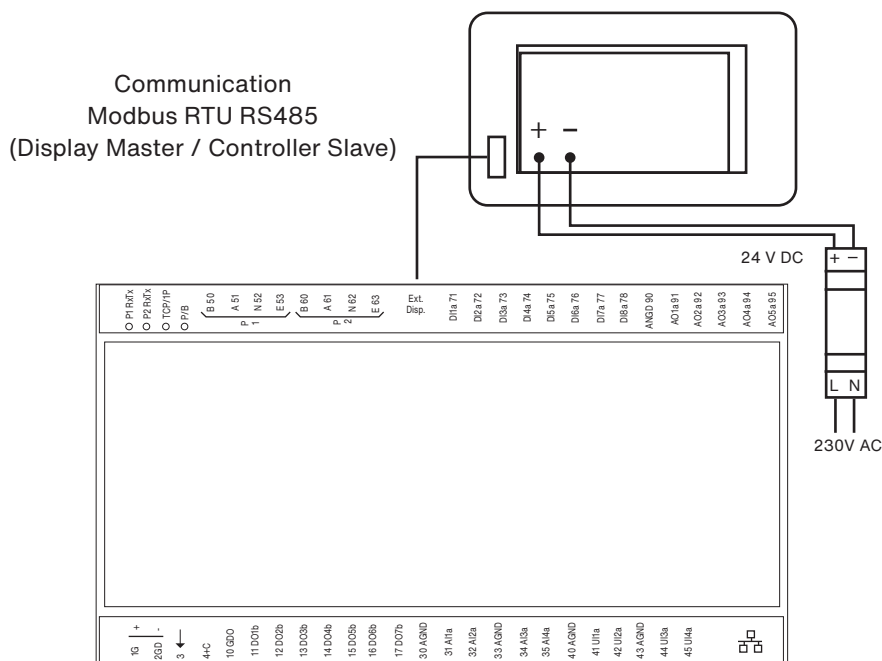



The screen is powered by a 230V AC / 24V DC transformer and communicates with the CLD-283 controller in Modbus RTU RS485 via the "Ext DISP" port . The screen is the master and the controller is the slave.

2. Physical presentation of the CLD-283 controller

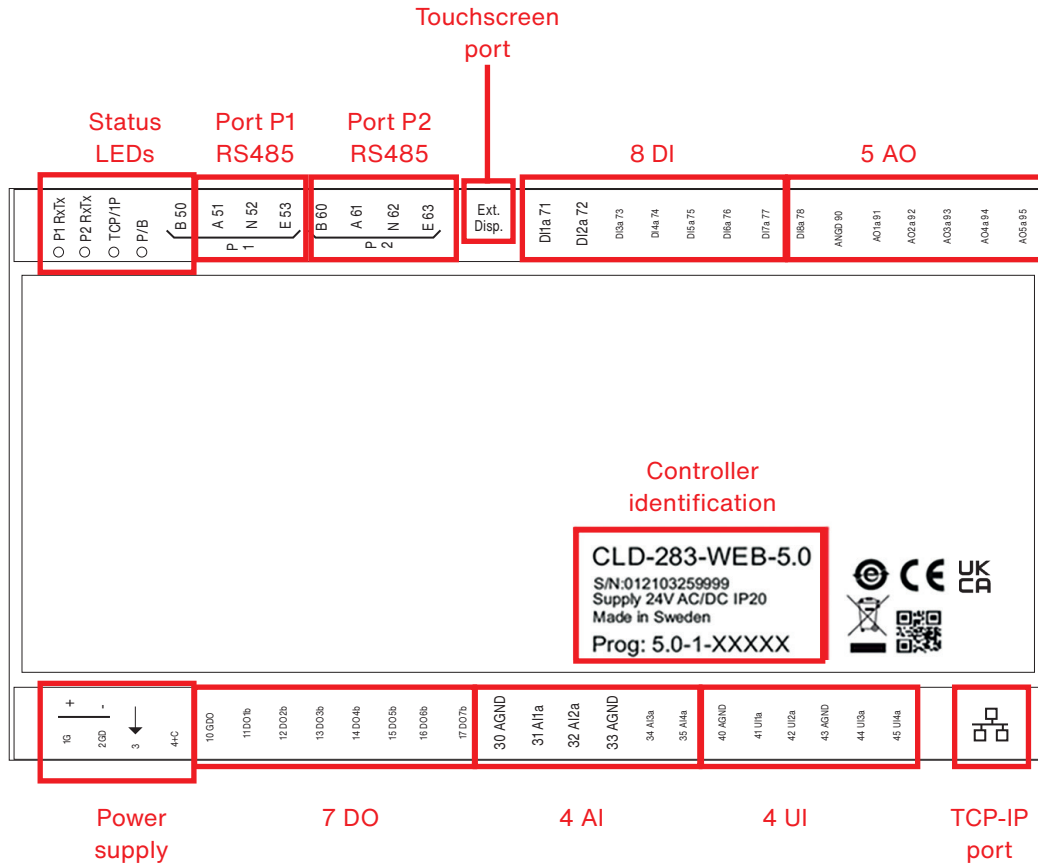
The CLD-283 controller is physically very similar to the previous version. The number of inputs/outputs remains unchanged, as do the dimensional characteristics.

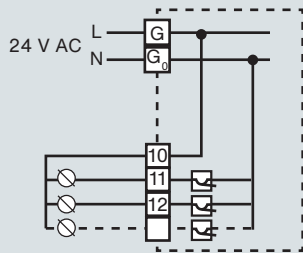

Terminal	Definition	Details
G0 (+)	24V AC power supply	G (+) is also used to power TRPS, TRPR, CO ₂ sensors.
G0 (-)		
	Grounding	
+C (24V DC)	24V DC voltage source used only for DI and UI.	It is a 24V DC (stabilised direct current) voltage source.
Illuminated indications by (4) LEDs		
P1 RxTx	Status LED for RS485 port 1.	The LED flashes when communication is active. The LED is off when there is no active communication.
P2 RxTx	Status LED for port 2 reserved for communication with another expansion controller.	
TCP/IP	Status LED for TCP/ IP port.	
P/B	Status LED of the board (Printed Board).	The LED is lit when the controller is switched on.

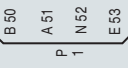
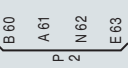
(7) Digital outputs DO		
GDO	Common to DOs and internally connected to G (+)	
DO1...DO7	24V AC polarised outputs (controller supply voltage), connected to G0 (-) internally	The DO outputs provided for the user must be relayed or the 3.15A protection fuse on the controller's 24V AC power supply will blow.
(5) Analogue outputs AO		
AGND	Common	
AO1...AO5	Outputs configured as 0-10V.	
(8) Digital inputs DI		
AGND	Common	
DI1...DI8	24V DC polarised inputs (dry contact between +C and the corresponding DI input).	
(4) Analogue inputs AI		
AGND	Common	
AI1...AI4	Inputs configured as PT1000 or 0-10V depending on the machine version (see electrical diagram for the machine)	
(4) Universal inputs UI		
AGND	Common	
UI1...UI4	Inputs can be configured as analogue input AI or digital input DI depending on the machine version (see electrical diagram for machine)	
(1) TCP-IP port		
	Port reserved for communication between the machine and a BMS via TCP-IP link. RJ45 plug interface	Available protocols: Bacnet IP or Modbus TCP
(1) Port P1 RS485 (Port P1)		
	Reserved port for communication between the machine and a BMS via RS485 serial link. Screw connector interface	Available protocols: Bacnet MS/ TP or Modbus RTU
(1) Port P2 RS485 (Port P2)		
	Port reserved for communication with another controller or for communication with the Zehnder EDT2 remote touchscreen.	
(1) PG 5.0 touchscreen communication port		
Ext. Disp.	Port reserved for communication with the PG 5.0 touchscreen.	

3. Electrical connection controller CLD-283/PG 5.0 DISPLAY

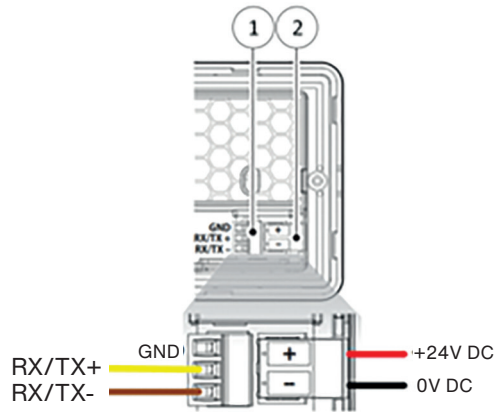

1	Modbus communication plug
2	24V DC power supply plug

The display has a 2-pole plug for 24V DC power supply and a 3-pole plug to allow Modbus communication with the controller.

4. Zehnder Easy 5.0 and Zehnder EDT2 remote touchscreen controllers (Optional)

4.1. Zehnder Easy 5.0 wall-mounted touchscreen master control

The touchscreen is available as an option for remote operation from the ventilation unit up to a distance of 100m.

The optional kit is comprised of:

- A portable screen
- An electrical harness that can be extended to the desired length up to 100m
- A screen cover
- One wall mounting plate for surface mounting.

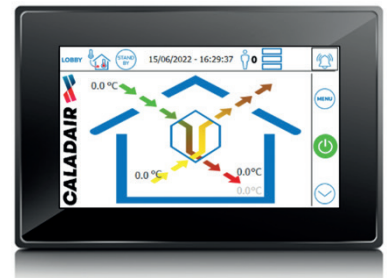

The electrical connection between the remote display and the ventilation unit is the responsibility of the installer. Observe the electrical connection indicated in chapter III ELECTRICAL CONNECTION CLD-283 CONTROLLER/PG 5.0. DISPLAY. To extend the supplied electrical harness, use:

- a 2x0.75mm² cable (or equivalent) for the 24V DC power supply
- A Belden 3106A cable (or equivalent) for communication.

It is not possible to operate the on-board touch control and the remote touch control simultaneously. Only one control at a time can function. The general electrical control diagram is available in the installation and operating instructions of the ventilation unit.

For quick access during maintenance, consider reconnecting the faceplate screen instead of the remote screen.

4.2. Zehnder EDT2 wall-mounted touchscreen user controller

The Zehnder EDT2 wall-mounted touchscreen user controller is an optional room touch controller for end users. It offers simplified functionality compared to the Zehnder Easy 5.0 wall-mounted touchscreen master controller.

See manual MS-REL-002 - Zehnder EDT2 for the use and installation of the Zehnder EDT2 wall-mounted touchscreen user controller.



5. Definition of thermal sequences

5.1. General

The temperature control is defined by 3 different thermal sequences illustrated by a pictogram visible from the main screen (the size of the coloured area indicates the calculated requirement of the sequence):

- Cooling sequence (management of the cold coil: BF cold water coil, DX or DXR direct expansion coil, CO coil depending on version).
- Recovery sequence (managed by rotary or plate heat exchanger depending on version)
- Heating sequence (management of the heating coil: electric coil BE, water coil BC, changeover coil CO, reversible direct expansion coil DXR according to version)

Each sequence is managed by its own PID parameters, and each sequence is connected to an analogue output (AO) (see electrical diagram for the relevant machine).

In the case of a rotary heat exchanger, the recovery sequence depends on the speed of rotation of the wheel: the faster the wheel turns, the greater the heat recovery. When it is not operating, there is no heat recovery, and this is also the case when running in free cooling or free heating mode.

In the case of a plate heat exchanger, the recovery sequence acts on the opening angle of the bypass flap: the more the bypass closes, the greater the fresh air volume passing through the exchanger and the greater the heat recovery. The bypass also provides anti-icing (specific PID parameters), free cooling and free heating functions.

These 3 sequences work in succession according to the following descriptive diagrams.

Thermal sequences with heat recovery requirements:

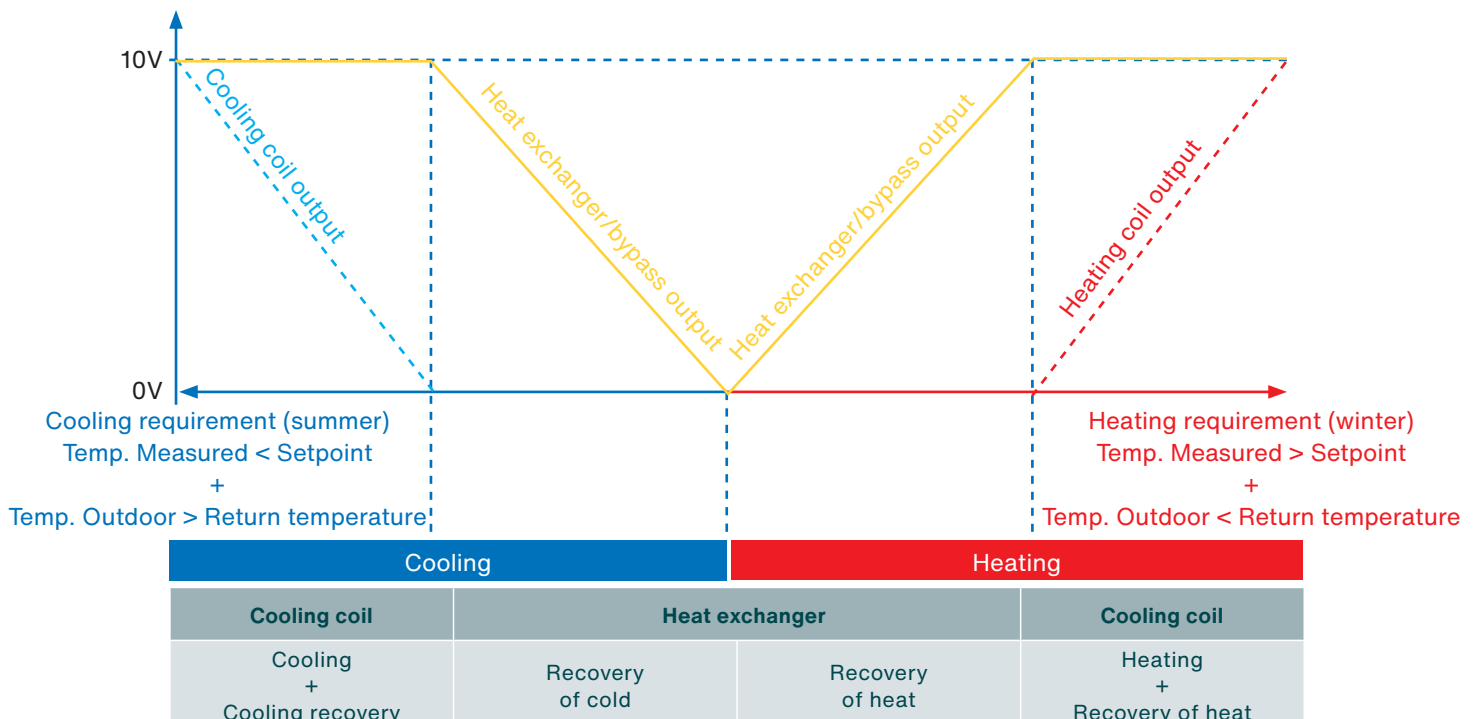

Thermal sequences with no heat recovery requirements:

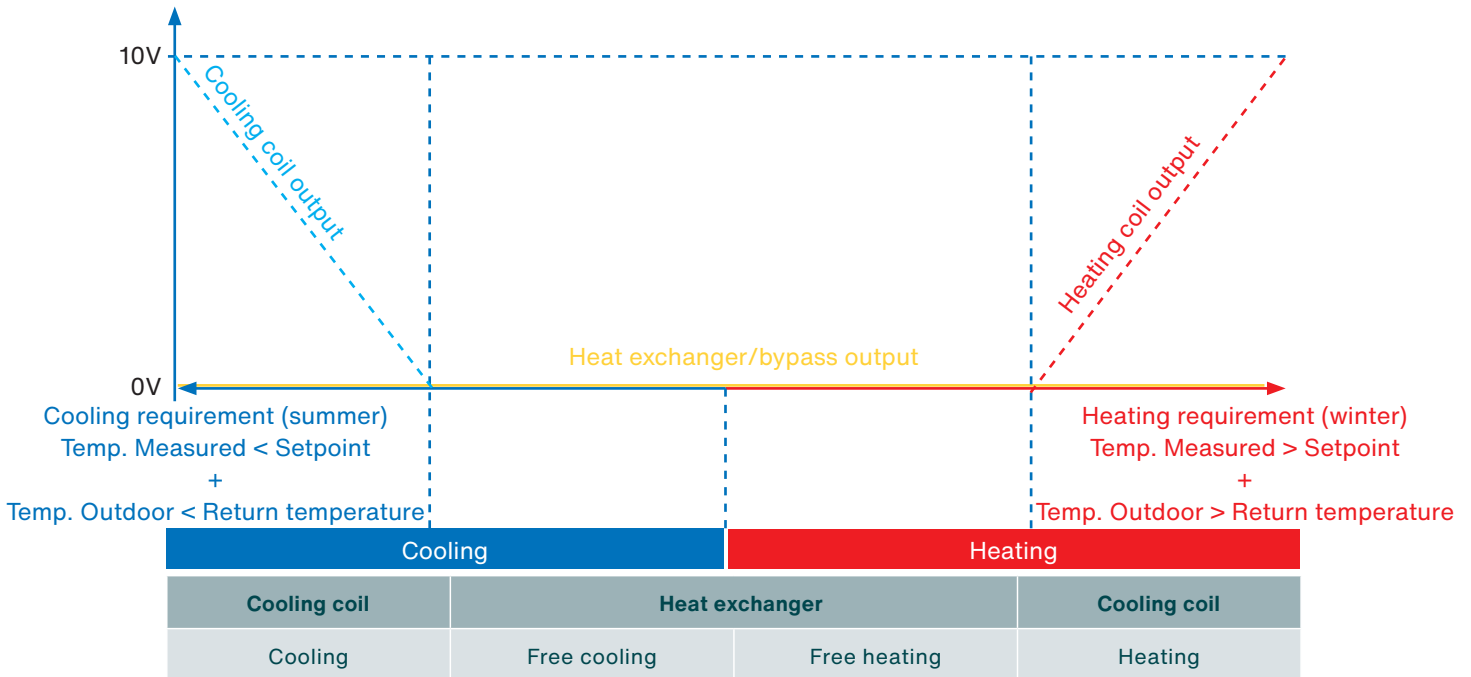

5.2. Demand and need for heating

The heating coil (hot water or electric) operates when heat is required, which is when:

- The measured supply air temperature is lower than the setpoint supply air temperature (supply air temperature control mode)
- The measured return air temperature is lower than the setpoint return air temperature (return air temperature control mode).

The operation of the electric heating coil depends on the operation of the supply air fan: when there is an alarm (ID = 1 Supply air fan alarm) or when the anti-icing function is activated by lowering the supply air volume, the electric heating coil is immediately switched off in order to prevent the heating element and its immediate vicinity from overheating.

5.3. Demand and need for cooling

The cold water cooling coil operates when cooling is required, which is when:

- The measured supply air temperature is higher than the setpoint supply air temperature (supply air temperature control mode)
- The measured return air temperature is higher than the setpoint return air temperature (return air temperature control mode)

5.4. Demand and need for heat recovery

The heat exchanger operates when there is a need for heat recovery. This is the case when:

- There is a heating requirement and the extraction temperature is higher than the fresh air temperature (the fresh air is preheated)
- There is a need for cooling and the return air temperature is lower than the fresh air temperature.

Depending on the need for heat recovery, the controller will act either on the opening angle of the bypass flap (plate heat exchanger) or on the speed of rotation of the rotary exchanger (rotary heat exchanger).

6. Initialisation of thermal sequences at start-up

Initialisation at start-up allows the machine to be started at an operating point that is as close as possible to the one that will be recalculated during operation in order to avoid any source of discomfort and unnecessary energy consumption.

The initialisation of the thermal sequence at start-up depends on the outdoor temperature measured at the time the machine is started:

Outdoor temperature < +3°C	Outdoor temperature ≥ +3°C
The unit starts when 100% heat is required*. As long as the feedback signal from the supply air fan is off*, the heating coil BE is not activated.	The unit starts with maximum energy recovery.

* The control output of the 3-way valve or the control output of the electric heating coil is at 100% (10V).

** ECO/DIVA: the DEP S pressure switch contact is open; LOBBY: the pressure signal is below the minimum threshold; MAC2/QUATTRO: the air volume signal is below the minimum threshold.

7. Start-up sequence

When the startup sequence is active, it can be identified by the pictogram in the  in the “operating mode” area of the home page.

The start-up sequence is activated when all the following conditions are met:

- The unit is ON 
- There are no active class A alarms (alarms that shut down the unit)
- The external shutdown command is not active
- At least one time schedule (reduced operation or normal operation) is active, or a forced operation (normal operation or reduced operation) is active, or the anti-fire function configured to start the unit is active, or there is a request for operation from the BMS.

The start-up sequence takes a total of 120 seconds. During this time, the alarms are disabled (except for the THS electric battery overheating alarm (63), which is monitored during this period) and the AHU starts up at the operating point defined at the initialisation of the thermal sequences at start-up. The minimum fan control signal does not apply.

The fresh air and exhaust air registers open as soon as the start sequence is activated. The control signal for the return air fan is enabled 15 seconds after the start sequence is activated. 15 seconds later, the control signal for the supply air fan is enabled and the supply air fan starts. The outputs for controlling the 3-way valves and the heating or cooling pumps are activated.

Once the 120 seconds have elapsed, the fan unit switches to normal mode at the end of the start-up sequence. The minimum and maximum fan control signal is then taken into account and the alarm monitoring function is activated.

In the event of a power failure, the unit will automatically restart as soon as the power supply is restored.

8. Shutdown sequence





When the shutdown sequence is active, it can be identified by the pictogram in the  in the “operating mode” area of the home page.

The shutdown sequence occurs when at least one of the following conditions is met:

- Appearance of an alarm whose action requires the normal shutdown of the unit (note that some alarms are programmed for rapid shutdown, in which case the shutdown sequence is ignored and the unit shuts down immediately)
- The unit is switched to OFF 
- No active time schedule
- The anti-fire function is set to stop the unit
- Shutdown request from the BMS.

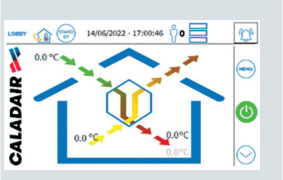
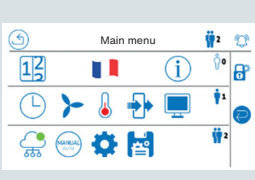
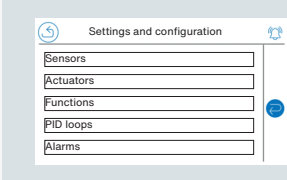
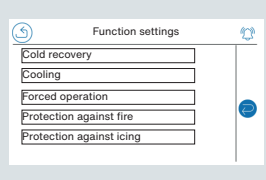
The shutdown sequence lasts for a time related to the setting of the fan shutdown time limits (post-ventilation) and the fresh air and exhaust air register closing time limits. When the shutdown sequence is activated, the alarm management function and the electric coil output are immediately deactivated (the hot/cold water and recovery coil outputs remain active). The supply air fan is switched off after 180 seconds. The return air fan is switched off 30 seconds later. The fresh air and return air registers are closed 5 seconds after the return air fan has stopped and all actuator control signals are deactivated.

9. Night cooling function

Access path to the function (Access level: Expert)							
	Step 1	→	Step 2	→	Step 3	→	Step 4
From screen							
Area to click							

When night cooling is active, it can be identified by the pictogram in the  in the “operating mode” area of the home page.

Night cooling takes advantage of the cool conditions outside at night to lower the temperature of the building and extract the energy accumulated during the day. This function allows the temperature to be maintained the following day at a level that ensures greater comfort while limiting energy consumption for cold production. A specific fan setpoint (fan offset) can be set to change (plus or minus) the air volume when the function is active.

The activation of night cooling requires thermal conditions to be met both during the day and also during the night period (00:00 - 07:00 factory setting) for which it is programmed.

The cooling function is managed by the following parameters:

Parameter	Configuration	Factory setting
Authorisation to run (user condition)	Activated	Activated
	Deactivated	
Time range for operating authorisation	Start time (adjustable)	00:00
	End time (adjustable)	07:00
Fan offset (applied to normal HS setpoints)	Supply air fan (adjustable)	0
	Return air fan (adjustable)	0
Outdoor temperature threshold reached during the day	(Adjustable)	22 °C
Outdoor temperature range during the night cooling period	Maximum temperature (adjustable)	35 °C
	Minimum temperature (adjustable)	14 °C
Minimum recovery temperature threshold during the night cooling period	(Adjustable)	18 °C
Return temperature difference - outdoor temperature	(Adjustable)	2 °C
Blocking time of the hot outputs after night cooling	(Adjustable)	180 minutes
Time between 2 test runs	(Adjustable)	60 minutes
Time to check all temperature sensors	(Adjustable)	180 seconds

Fan setpoints:

When cooling is operational, the fan setpoints automatically switch to the normal setpoints plus an offset if this is configured. In the ECO, DIVA, MAC2 and QUATTRO versions, the normal fan speed setpoints are higher than the reduced speed setpoints in order to take full advantage of the function. In the LOBBY version, a normal operation setpoint corresponding to the night cooling setpoint will be configured.

If the air distribution network is equipped with motorised control registers (especially in LOBBY constant pressure), it is necessary to force their opening by using the activation signal of the cooling function, otherwise the air volume will remain blocked and the function will be of little use. A cooling fan offset can also be set if you want to ensure that you achieve an air volume close to the maximum air volume of the machine.

Time setpoints:

Care should be taken not to overlap the normal operation time period with the cooling time period because this would have the effect of inhibiting the cooling function over the recovery time of the two functions (the cooling activation signal and the fan offsets will not be operational). Cooling can only be started if the time period for reduced operation is running or if the central ventilation unit is switched off.

All of the following conditions must be met to activate the function:

- The user has authorised the cooling operation (accessible parameter)
- Fewer than 4 days have passed since the unit was operated in reduced or normal mode
- A time schedule must be active within the next 24 hours
- The daytime outdoor temperature has exceeded the set threshold (22°C adjustable)
- Normal operation, external forced operation and restart must be off (not active)
- The current time is within the permitted operating range (00:00 - 7:00, adjustable)
- The difference between the return air temperature and the outdoor temperature is insufficient (2°C adjustable with a hysteresis of 0.5°C).

When the function is activated, the machine goes through a stop and start phase. It then starts a phase of 180 seconds (adjustable) during which the unit operates with the cooling parameters set (normal operation fan setpoint + offset if present) in order to properly irrigate the temperature sensors and ensure that the measured values are stabilised and reflect the current situation.

Once this has finished, the shutdown conditions are checked. If at least one of the following conditions exists, then the unit quits the cooling function:

- The outdoor temperature is outside the permitted range:
 - Outdoor temperature > 35°C
 - Outdoor temperature <14°C
- The return air temperature is below the specified value (18°C)
- Normal operation, external forced operation and restart must be off (not active)
- The difference between the return air temperature and the outdoor temperature is sufficient (2°C adjustable)
- The end time (07:00) has been exceeded.

When night cooling has been activated, the heating outputs are deactivated 180 minutes (adjustable) after the night cooling function has been exited, in order not to lose the accumulated energy and comfort benefits.





Example: heating can only be switched on from 08:00 if cooling was stopped at 05:00, although the end time is set to 07:00.

If the activation conditions are met again, the fan offset will only be active after a time limit of 60 minutes from the time the cooling function was exited.

When cooling is active:

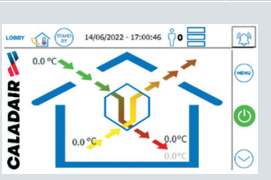
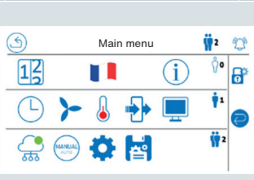
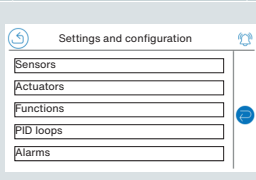
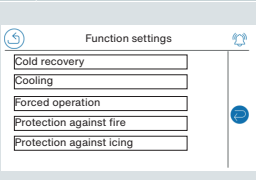
- The DO output cooling (NO) is closed. This change of state must be used to force open any registers placed on the air distribution network (LOBBY constant pressure network)
- The normal operation fan setpoint is used and an adjustable offset (positive or negative) is applied if this is set.

10. Anti-icing function by reducing the air volume

Access path to the function (Access level: Expert)											
Step 1		→	Step 2		→	Step 3		→	Step 4		
From screen											
	Area to click										

dropping too low, which could lead to the icing of its water vapour and thus the clogging of the exchanger. This function can be considered when the building is heated mainly by generators whose energy cost is cheaper than if an electric Joule heat exchanger is used to preheat the fresh air, or when there are power supply/power constraints. In effect, the function limits the electrical power consumed by the machine, which is particularly useful in certain countries or regions during the winter.

It should be noted that stopping/reducing the supply air volume and maintaining the return air volume at the nominal value requires fresh air inlets at the windows (or any other similar device) in order to control the pressure in the building and the minimum air volume at the return.

This function is activated when the 2 conditions below are met:

- The anti-icing sequence by bypassing the fresh air volume (see XXVII.3 Protecting the plate heat exchanger against icing) is active
- The measured outdoor temperature is below the set threshold (-100°C factory setting, configurable value).

When the function is active, the supply air fan setpoint changes to the minimum signal value of 25% (2.5V, not adjustable) regardless of the fan control type (ECO/DIVA/LOBBY/MAC2/QUATTRO).

To allow the supply air fan to resume normal operation, the fresh air temperature must return to above the set threshold (+1°C) AND the fresh air bypass anti-icing function must be reset. This does not always happen instantly depending on the PID settings.

The factory setting of the outdoor activation temperature threshold is -100°C, which makes this function inactive. To activate it, it is necessary to change this value to about -10°C.

It is not recommended to activate this function on SMART or INFINITE machines equipped with an electric fresh air preheating coil. This is because the fresh air volume becomes low (fan control signal at minimum) when the function is activated, which could lead to overheating of the fresh air preheating coil.

Fan control					Exchanger type		Heating coil type		Thermal control
ECO	LOBBY	MAC2	DIVA	QUATTRO	PLAQUE	ROUE	BE	BC	SMART/INFINITE (Fresh air preheating coil)
✓	✓	✓	✓	✓	✓	—	✓	✓	✗

✓ = Possible ✗ = Not recommended — = Non-functional

If an electric heating coil is integrated in the machine, it will be deactivated for as long as the function is active in order to avoid excessive overheating of the heating element and its immediate vicinity.

This function is not used in machines with a rotary heat exchanger.

11. Anti-fire function

11.1. General information on the function and its possible configuration

Access path to the function (Access level: Expert)										
Step 1		→	Step 2		→	Step 3		→	Step 4	
From screen										
	Area to click						Functions		Protection against fire	

When the anti-fire function is active, it can be identified by the pictogram in the “operating mode” area of the home page.

The anti-fire function is activated when the corresponding digital input DI is active.

It allows the machine to be forced to operate on sequences specific to the anti-fire function. This function is inactive when the unit leaves factory and must be configured when the machine is commissioned.

The anti-fire function cannot be used to control fire dampers. The management and control of these components should be done independently, if necessary.

When the anti-fire function is activated, the bypass control output of the plate heat exchanger is deactivated and the fresh air is diverted from the plate heat exchanger.

Only the behaviour of the unit, fans and isolation registers can be configured when the anti-fire function is activated.

In the case of a rotary heat exchanger, the recovery sequence remains on auto if the selected operating mode allows the machine to operate.











Parameter	Possible choices	Details
Function activation	Activated or deactivated	Enables the operation or non-operation of the anti-fire function.
Operating mode	Stop	The machine is stopped when the anti-fire function is active. The fans are switched off immediately even with a declared heating BE; there is no post-ventilation.
	Continue	The machine operates continuously without taking into account the time schedules with the fan settings below(1).
	Under normal start/stop conditions	The machine operates according to the time schedule.
	Supply only	The supply air fan only operates according to the corresponding setpoint below(1).
	Return only	The return air fan only operates according to the corresponding setpoint below(2).
(1)Supply air fan setpoint	Auto	The fan runs at the speed/pressure/volume requested by the time schedule. It may be at a standstill if a shutdown phase is programmed.
	100% manual output	The fan runs at maximum speed regardless of the type of control (speed/pressure/volume)
	Reduced operation	The fan rotates at the corresponding reduced speed/pressure/volume.
	Normal operation	The fan rotates at the corresponding normal speed/pressure/volume.
(2)Return air fan setpoint	Auto	The fan runs at the speed/pressure/volume requested by the time schedule. It may be at a standstill if a shutdown phase is programmed.
	100% manual output	The fan runs at maximum speed regardless of the type of control (speed/pressure/volume)
	Reduced operation	The fan rotates at the corresponding reduced speed/pressure/volume.
	Normal operation	The fan rotates at the corresponding normal speed/pressure/volume.
Fresh air register position setpoint	Fan function	The fresh air register is forced open if the fan is running or forced closed if it is not.
	Open	The fresh air register is forced open when the anti-fire function is activated.
	Closed	The fresh air register is forced closed when the anti-fire function is activated.
Exhaust air register position setpoint	Fan function	The exhaust air register is forced open if the fan is running or forced closed if it is not.
	Open	The exhaust air register is forced open when the anti-fire function is activated.
	Closed	The exhaust air register is forced closed when the anti-fire function is activated.
Plate heat exchanger sequence setpoint	Bypass open (parameter fixed and not accessible)	When the fire function is activated, the exchanger is bypassed.

11.2. Fire alarm (N°58)

The fire alarm has a factory setting of Class C (= warning), with a time limit of 1 second and no action.

12. Commissioning procedure

The commissioning procedure can follow the following sequence of steps:

Step	Symbol PG 5.0	Description	Additional information
1		Installation and electrical wiring of options (if present)	
1.1		3-way valves hot / cold	See installation manual
1.2		Hot / cold circulators	See installation manual
1.3		Changeover thermostat	See installation manual
1.4		External controls (smoke detection devices, fire detection devices, low-speed remote order, high-speed remote order, remote stop order, fire protection)	See installation manual
1.5		Signal reports (LOBBY night cooling, alarm reports)	See installation manual
1.6		Zehnder EDT2 remote room touch control	See specific Zehnder EDT2 product information sheet XXXV.6 Navigation and menu access
2		Controller date and time setting	XXXV.6 Navigation and menu access
3		Time change setting / summer winter automatic	XXXV.6 Navigation and menu access
4		Time period settings	XXXV.6 Navigation and menu access
5		Fan setpoint configuration	XXXV.6 Navigation and menu access 0 FAN CONTROL MODES
6		Temperature setpoint configuration	XXXV.6 Navigation and menu access XVIII TEMPERATURE CONTROL MODES
7		Wiring and setting of communication ports	XXXV.6 Navigation and menu access XVI BMS COMMUNICATION
8		Setting specific functions	XXXV.6 Navigation and menu access
8.1		Night cooling	IX NIGHT COOLING FUNCTION
8.2		Protection against fire	XI ANTI-FIRE FUNCTION
8.3		Protection against icing by reducing the supply air volume	ANTI-ICING FUNCTION BY REDUCING THE SUPPLY AIR VOLUME
9	 	Checking the correct operation and adjustment of PIDs	XXXV.6 Navigation and menu access XXXIII HELP WITH SETTING PID PARAMETERS
10		Save user settings*	XXXV.6 Navigation and menu access

*By using the save user settings function at the end of the commissioning process, a normally functional configuration can be restored at any time.

13. Time period settings

13.1. General

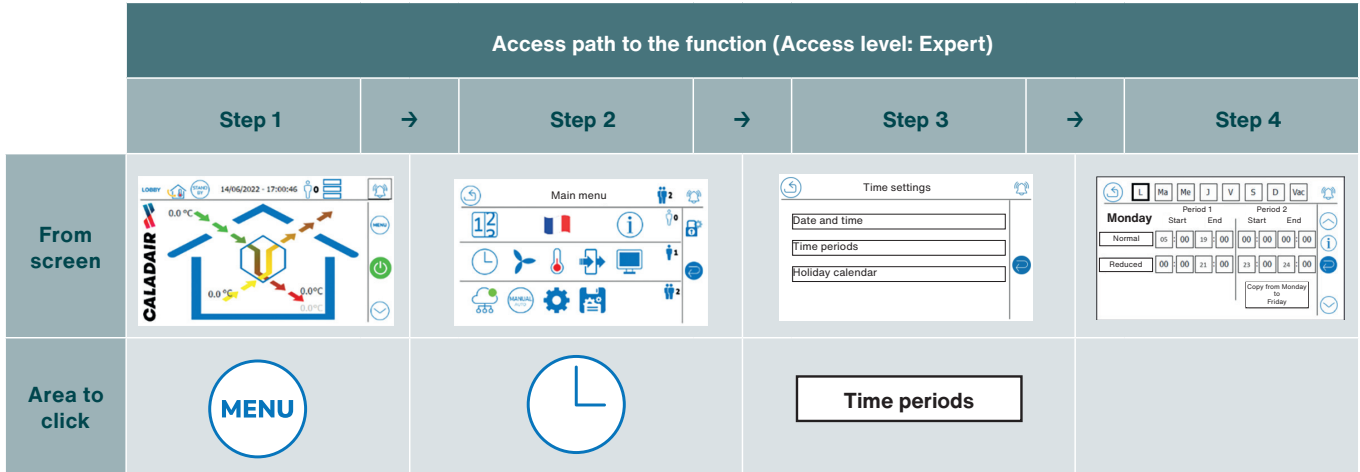

The setting of the time periods is to be adapted according to the type of occupancy in the area served by the ventilation unit, and whether the ventilation unit should maintain thermal comfort or not. The setting of the time periods involves combining 2 adjustable ventilation levels (reduced operation / normal operation) with 2 adjustable time periods (period 1 / period 2) for all days of the week and for the day that is assigned to the “holiday” periods.

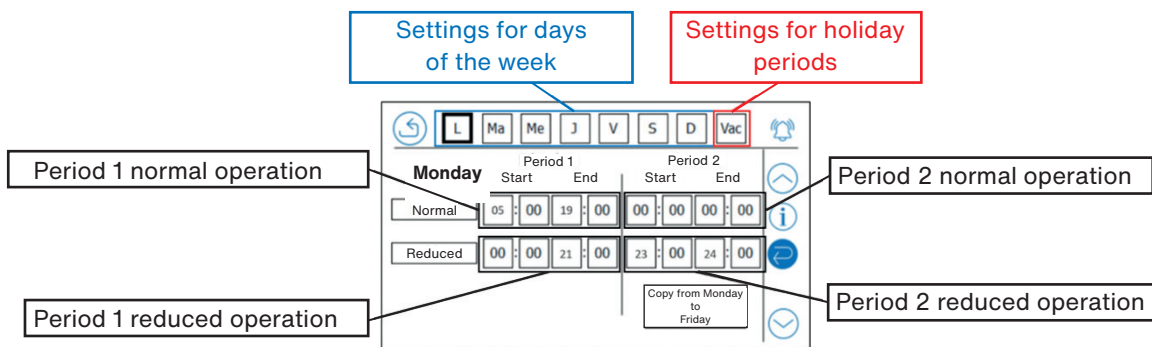

For each time period, it is necessary to set the start time and the end time.

Principle of timetable setting:

- 00:00 - 00:00 means that the period is not active
- 00:00 - 24:00 means that the period is permanently active
- 07:00 - 19:00 means that the period is active from 07:00 to 19:00

13.2. Priorities for time periods and external controls

Where time periods overlap, the following should be considered:

- When a reduced operation time period and a normal operation time period overlap, the normal operation time period has priority over the reduced operation time period
- When there is no active operation, i.e. when neither the reduced nor the normal operation is active, the ventilation unit is switched off
- If the ventilation unit is stopped, it can be started if the night cooling function is allowed to operate in the set operating time range (00:00 - 07:00 factory setting)
- The night cooling function can only operate if the ventilation unit is:
 - In reduced operation
 - Stopped via time schedules (no active time schedules).

External controls have priority over time period programming. If the ventilation unit:

- Operates in the normal operation time schedule and the external forced operation in reduced operation is activated, the ventilation unit will operate in reduced operation
- Operates in the reduced operation time schedule and the external forced operation in normal operation is activated, the ventilation unit will operate in normal operation
- Is off (no active time schedule) and the forced running in reduced (or normal) operation is activated, the unit will operate in reduced (or normal) operation the whole time the forced running in reduced (or normal) operation is activated
- Is operating in the reduced (or normal) operation time schedule and the external forced operation is activated, the ventilation unit will be switched off.

The night cooling function will only be started if:

- The time schedule that covers the cooling period is the reduced operation
- Or the ventilation unit is stopped by the time schedules (no active time schedule)
- And there is no demand for an external forced operation.

Due to the risk of internal deterioration of the fan unit and clogging of the pressure tap tubes by condensation, it is generally not recommended to have shutdown phases, especially because:

- These shutdown phases are short and repeated
- The exhaust air is humid
- The machine is installed outdoors, in a cold region, and without isolation registers.

For these reasons, it is recommended to have at least the reduced operation period permanently active (setting 00:00 - 24:00).

The diagram below summarises the operating logic for the following time schedule setting:

Mo Tu We Tu Fri Sa So Vac

Monday

Period 1 Start End | Period 2 Start End

Normal 05:00 19:00 | 00:00 00:00

Reduced 00:00 21:00 | 23:00 24:00

Copy from Monday to Friday

Programming of time schedules (Monday)

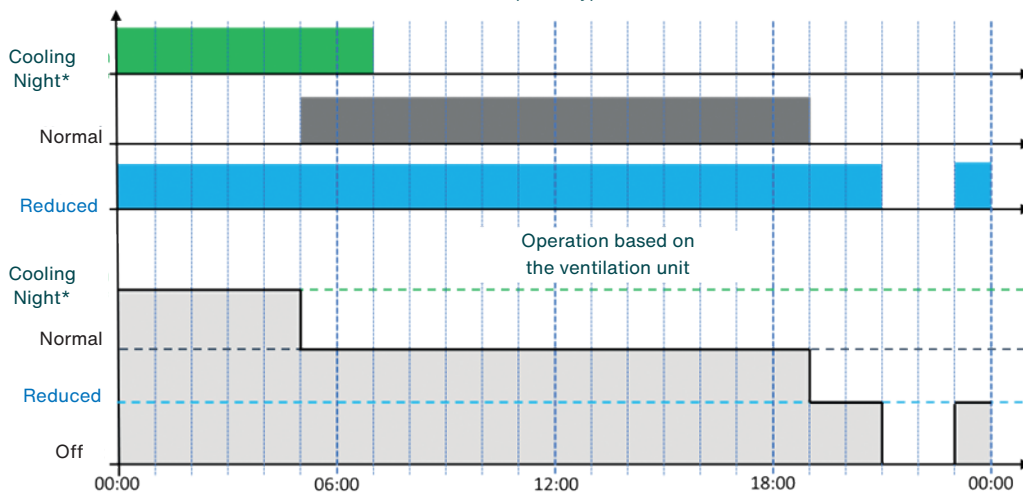

*The night cooling will only work if the activation conditions are met.
If different settings are required on other days of the week, set the time schedules for the corresponding days accordingly.

13.3. Holiday calendar

Access path to the function (Access level: Service)						
Step 1	→	Step 2	→	Step 3	→	Step 4
<p>From screen</p>		<p>Main menu</p>		<p>Time settings</p>		<p>Holiday calendar 1/ 2</p>
<p>Area to click</p>				<p>Holiday calendar</p>		

The holiday calendar gives the option of specifying daily periods of particular operation (other than weekdays) generally assigned to periods when the building is unoccupied (holidays) in order to reduce the energy consumption and the operating costs of the ventilation unit.

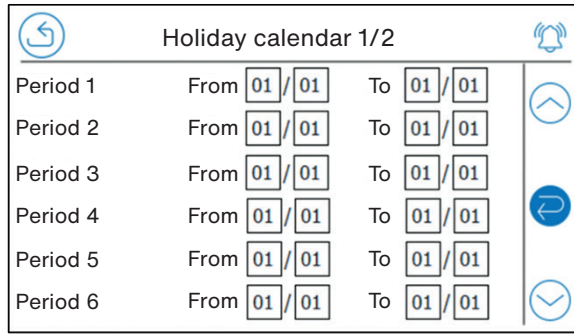

By default, the 1st day of the year is a day that is part of the holiday period. The “holiday” time period must be set in advance.

The holiday period is defined by a start day/month and an end day/month. Up to 12 different periods can be set. The so-called “holiday” period can therefore extend over several days, weeks or even months.

13.4. Recommendations for time schedule settings in the LOBBY version

When the ventilation unit is operated at constant pressure (LOBBY), the air distribution network usually imposes a single operating pressure. As a result, a single setting for supply and return pressure is sufficient. It is therefore not necessary to activate the normal operation period, and only the reduced operation period can be used. This therefore ensures that the night cooling function remains in operation if it is used.

However, if the normal operation time schedule is required, it should not overlap with the night cooling time schedule (00:00 - 07:00) to avoid disrupting the operation of the night cooling function.

Below is an example of time schedule (left) and ventilation (right) settings for the optimal operation of a LOBBY control:

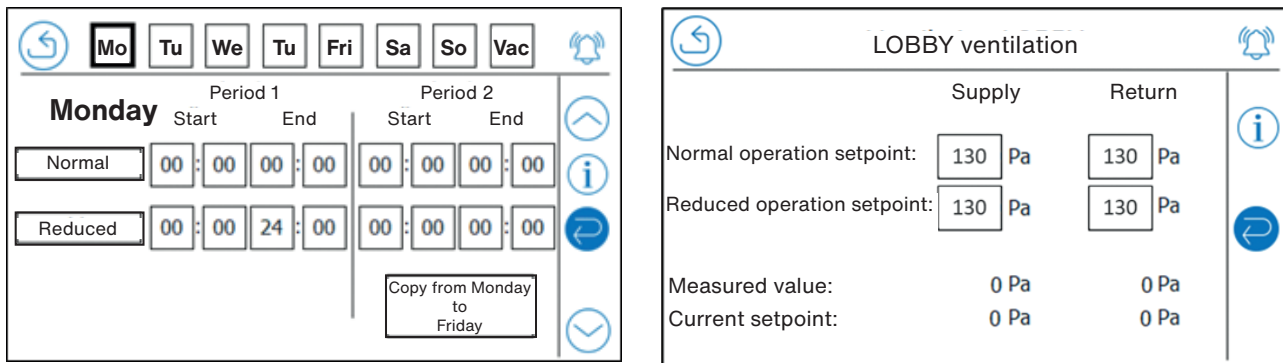

13.5. Recommendations for time schedule settings in the DIVA and QUATTRO versions

The time schedule associated with the normal speed does not allow the fan speed (DIVA) or the air volume (QUATTRO) to be regulated according to the CO₂ level.

In order for the CO₂ control to function properly, the desired time schedule must be linked to reduced operation only. The reduced speed must therefore always be programmed during the period when the zone is occupied, and the rest of the time to ensure minimum air circulation, which results in the following setting:

	Period 1		Period 2	
	Start	End	Start	End
Normal	00:00	00:00	00:00	00:00
Reduced	00:00	24:00	00:00	00:00

Copy from Monday to Friday

The use of a normal operation schedule allows the fans to be forced to the normal operation setpoint without CO₂ management. This can be useful, for example, when you want to purify the atmosphere between two periods of occupancy.

13.6. Recommendations for time schedule settings in the ECO et MAC2 versions

In the ECO or MAC2 versions it is necessary to distinguish:

- The period of occupancy of the building (or zone) to which the normal operation will be linked
- The period of occupancy of the building (or zone) to which the reduced operation will be linked.

The example setting below corresponds to an occupation of the zone served by the ventilation unit between 07:00 and 19:00. During this time, the ventilation unit runs in normal operation to ensure the required comfort and air quality. The rest of the time, the ventilation unit runs in reduced operation to limit energy consumption. If the conditions for activating the night cooling function are met, it will operate during the set time frame (00:00 - 07:00 factory setting).

	Period 1		Period 2	
	Start	End	Start	End
Normal	00:00	00:00	00:00	00:00
Reduced	00:00	24:00	00:00	00:00

Copy from Monday to Friday

14. Maintenance and fault diagnosis

14.1. General

Reasons for malfunctions are either:

- Outside the machine:
 - special air volume network, presence of regulated registers, etc.
 - BMS/CTM sending the wrong setpoints
- Inside the machine:
 - probes, sensors, actuators, wiring, etc.

In most cases, the fault will be visible on the machine (presence of an alarm), but this does not necessarily mean that the cause is in the machine itself and prior checks must be carried out before diagnosis.

14.2. Checks prior to any diagnosis

Before undertaking any diagnosis procedure, the technician must:

- check the network and its compatibility with the unit, in particular:
 - Actual layout: does the nominal operating point of the system (unit + network) enable the unit to operate correctly?
 - Examples: MAC2/QUATTRO: duct network diameter too small, LOBBY: duct network too short, etc.)
 - Type of fan controller (speed, pressure or volume): is the type of fan controller in the unit consistent with the type of network?
 - Do the control devices (zone registers) installed in the network have the correct dynamics and minimum/maximum opening positions for the unit?
- Check for active alarms (active alarms menu) which indicate that there is currently a problem and point to possible causes
- Check the alarm history (alarm history menu) which shows the last 100 recorded alarms. The time and date the alarms occur is important because you can check if the problems happen on a regular basis (e.g. every day at the same time), or if they correspond to particular times that could correspond to the setting of the time schedules (reduced operation, normal operation, night cooling, etc.), which could imply a wrong setting in this respect.
- Check the power supply to the controller (24V AC) or the lighting of the green P/B LED on the faceplate of the controller
- Check that there are no external forced operation setpoints (low-speed remote order, high-speed remote order, stop order)
 - Check the status of the digital inputs (DI) and the wiring
- Check that there are no external setpoints from the communication (ports P1 or TCP-IP). To do this, the technician must:
 - Check the physical presence of the wiring on the corresponding ports and disconnect if necessary
 - The flashing green LEDs P1RxTx and TCP/IP on the controller faceplate indicate that there is communication between the controller and an external device (BMS/CTM). Communication takes precedence over external setpoints (DI), which in turn take precedence over internal setpoints (time programming).
 - The presence of a particular operating mode forced by the BMS/CTM is visible from the “BMS request” status on home page 3 (see XXXV.5.c Home page 3).
- Check that there is no function in manual mode
- Check the machine settings:
 - time schedules (night cooling, reduced operation, normal operation, shutdown period)
 - Fan setpoints
 - Temperature setpoints
- Check the condition of the filters and replace if necessary
- Check that the electrical terminals and plugs are properly tightened.

14.3. Simplified diagnosis

As a first step, it is necessary to distinguish between a blocking fault (the machine is stopped and does not work) and a non-blocking fault (e.g. the machine works but stops/starts sporadically).

A blocking fault is characterised by the permanent presence of an active Class A alarm with “normal stop” action. For this type of alarm (e.g. electric heating coil overheating), as long as the cause has not disappeared and the alarm has not been manually acknowledged, the unit will not restart. It will also be necessary to physically reset the thermostat itself.

A non-blocking fault is characterised by the absence of an alarm (external fault in the machine), or by the presence of a class C alarm (warning).

The alarms and faults table (see XV.10 Alarms and faults table) summarises all possible alarms and faults and the causes and remedies that allow the diagnosis and checks to be made for each of them.

14.4. Advanced diagnosis

If the above steps have been carried out and the fault is still present, an advanced diagnosis is necessary. To do this, it is necessary to know the machine's control loops and the input/output information required for each of them.

14.4.1. Checking an active BMS

The setpoints from a BMS have priority over all other internal and external setpoints.

The automatic overwriting of a setpoint that has just been modified from the display by another value is a sign that a communication port is functional and an external system (BMS, CTM, etc.) is sending information to the controller from one of the P1 RS485 or TCP-IP communication ports.

The flashing green LEDs (see II PHYSICAL PRESENTATION OF THE CLD-283 CONTROLLER) and the physical electrical connection of the P1 RS485 or TCP-IP communication ports indicate whether a communication port is functional and active.

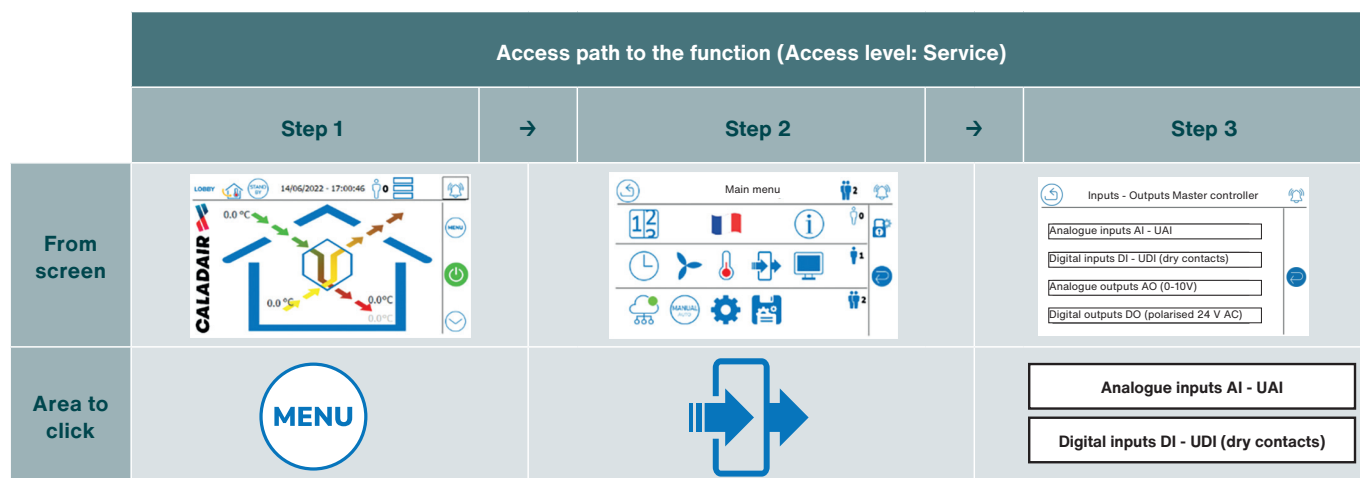

14.4.2. Input checks



A quick check of the measured values and the status of the inputs (AI/UI and DI) is a prerequisite for any diagnosis. This is because the state of the inputs determines the state of the outputs and therefore the operation of the machine. The table below sets out the main checks to be carried out on the various inputs:

Digital inputs	Description
Status of external setpoints (low-speed remote order, high-speed remote order, etc.)	External setpoints from the DIs have priority over configured setpoints. If, for example, the time schedule requires HS operation and the DI corresponding to forced LS operation is activated, the machine will operate in LS.
Input configuration	If a DI configured in the factory as NO is changed to NC and nothing is wired to the corresponding DI (which is the case when leaving the factory), this will most likely lead to a malfunction or undesired behaviour of the machine.
Wiring	Reverse wiring can lead to incorrect operation. For example, if a dry contact for external control to force the machine to run in HS is wired to DI5 instead of DI4, the machine will stop instead of running in HS.
Signal stability	For example: - Is the fresh air temperature stable? - Is the return air pressure stable? Instability can be caused by a problem in the measuring line, such as poor contact (probe/sensor, plugs, wiring, etc.), but also by a problem external to the machine (turbulence created by a curved air duct, etc.).
Signal plausibility	Does the measured value seem correct? For example, if a fresh air temperature of 25°C is measured when it is -5°C, it is easy to say that there is a measurement problem. It is usually necessary to have a second measuring device (temperature sensor, pressure sensor, etc.) independent of the machine to check this type of issue.
Consistency of the signal with other signals	Correct signal plausibility alone does not mean that there are no problems, especially with regard to temperature sensors. Here we will check whether all the measurements are consistent with each other in order to ensure that there is not, for example, a reversal in the mounting of the sensors (e.g. reversal of 2 temperature sensors).

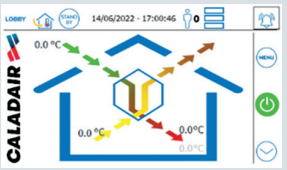
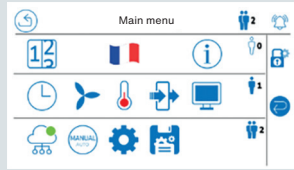
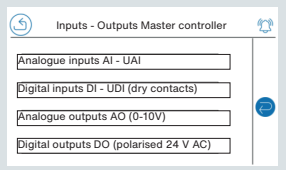
14.4.3. Output checks

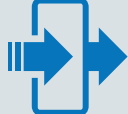
Access path to the function (Access level: Service)					
	Step 1	→	Step 2	→	Step 3
From screen					
Area to click					<div data-bbox="1125 649 1452 750" style="border: 1px solid black; padding: 5px;"> <p>Analogue outputs AO (0-10V)</p> </div> <div data-bbox="1125 750 1452 750" style="border: 1px solid black; padding: 5px;"> <p>Digital outputs (polarised 24 V AC)</p> </div>

Checking the outputs makes it possible to know the status of each output (DO or AO) of the controller, which ensures the control of the actuators (e.g. fans, register, etc.) or the transfer of information (e.g. status of cooling, etc.) which can be utilised by the machine operator.

Checking the outputs is a quick and simple way of ensuring that the signals/setpoints sent by the controller to the various actuators are consistent, and therefore the expected behaviour is known. For example, if the controller sends a speed setpoint of 7V to the supply air fan and the fan does not work, it is easy to imagine that the problem is either with the fan itself or between the fan and the controller (wiring, cabling, power supply, etc.).

The checking of the outputs is a check that is carried out on the machine during operation. Unfortunately, in some cases, it is possible that the fault will not allow some outputs to be checked because the machine is stopped (broken down), as in this case all outputs will be zero. This is especially the case when a Class A alarm with a Stop action is active.

In other cases, some outputs are only active or take on certain values when a number of conditions are met (e.g. cooling output) or when certain input signals have reached certain values, so it is difficult to control these outputs. The manual output control function can therefore be very useful in carrying out the diagnosis.

14.4.4. Manual control of outputs

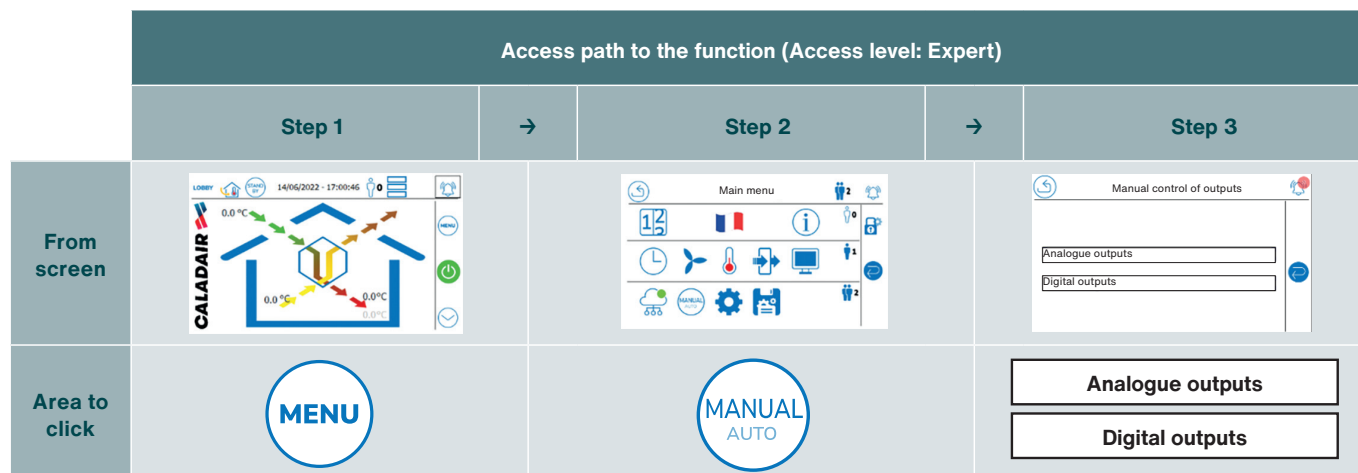

The controller has a manual control function for the analogue AO and digital DO outputs, which allows individual, continuous control of actuators and customer devices independently of the control and safety loops. This makes it possible to check, in particular:

- The status and correct operation of the controller's analogue (0-10V) or digital outputs
- The condition and functioning of the actuators (e.g. fan or motorised register)
- The correct operation of any external device wired by the installer or technician (e.g. alarm reporting)
- The correct operation of a running control device (e.g. air pressure switch).

Another advantage of the manual output control function is the ability to check the operation of certain sensors. In fact, by activating the fan and thus allowing air volume to circulate, certain inputs are affected directly, such as the change of state of the fan feedback pressure switch, which allows us to check the correct operation of this device.

The manual control function can also be used during the set-up phase because it allows the operation of certain actuators to be stabilised at specific points, thus making it possible to take readings or measurements (absorbed current, pressure, temperature, etc.) or to check the operation of external devices (alarm reporting, forcing the opening of registers during cooling, etc.).

The manual control of the outputs is a function that can only be accessed when the unit is OFF in order to avoid any improper intervention that could endanger the operator as well as the machine. The machine cannot be restarted if any outputs are in the manual status. All outputs must be in automatic mode in order to restart the machine.

Notes:

- Manual control of the rotary heat exchanger: it is necessary to activate the DO rotary heat exchanger to give the run command (power supply) to the exchanger
- Manual control of the fans: in addition to the targeted control of the fans, it is possible to control the correct operation of the air volume control pressure switches (ECO/DIVA), air pressure transducers (LOBBY) and air volume meters (MAC2/QUATTRO).

15. Alarms

15.1. General

The operation and management of the alarms are defined by several parameters:

- The class: A, B, or C
- The type of action
- The time limit and the unit of time
- The threshold (for certain parameters)

An alarm can have different states (statuses):

- Active
- Cancelled
- Acknowledged

When an alarm is active (in the active state) it is visible in the “active alarms” menu and is immediately recorded in the alarm memory (“alarm history” menu).

All this information is detailed below.

15.2. Alarm class

The alarm class defines how the alarm (or fault) is or should be acknowledged.

Class	Description
A	The cause has disappeared and the alarm must be manually acknowledged. It is not possible to acknowledge the alarm until the cause is removed. The manual acknowledgement ultimately gives the ventilation unit permission to restart.
B	Class A and B are identical. It is useful to be able to distinguish between actions for the same type of resetting.
C	The alarm is automatically acknowledged when the cause is removed. The alarm class (C) is mainly used as a warning, although depending on the configured action, it is possible to stop the machine. It is not possible to manually acknowledge this type of alarm.

15.3. Alarm action

The alarm action defines the behaviour of the machine when the corresponding alarm occurs. There are several actions:

Action	Description
Deactivated	When the alarm appears, the machine continues to operate as if nothing happened. This action is used for operating faults that are not critical to the safety or integrity of the machine (e.g. pressure difference, filter clogging). This type of action is similar to a warning.
Rapid stop	The post-ventilation sequence is not considered; all outputs are deactivated instantly when the alarm occurs.
Normal stop	The post-ventilation sequence is taken into account. This sequence is defined by the shutdown time limits of the fans and the fresh air and exhaust air registers.
Reduced speed (Reduced operation)	The alarm overrides the selected speed setting.
Normal speed (Normal operation)	

15.4. Alarm time limit and time unit

The time limit specifies how long the cause must be present to activate the alarm. The time limit is based on the time of occurrence.

It is a condition available for all alarms.

There is no time limit for the disappearance of the cause. When the cause disappears, the alarm is instantly cancelled.

15.5. Alarm threshold

For some alarms, in addition to the time limit condition, a second threshold condition must be set.

When the criterion has exceeded the threshold during the set time limit, the alarm switches to the active state.



The alarm threshold is available for alarms whose cause depends on an analogue value, for example: temperature too high, pressure or volume too low, etc.

15.6. Alarm state (or status)

When there is an alarm, it can take on several states depending on the state of the cause:

Alarm state (status)	Description
Active	The cause is currently present
Cancelled	The cause has disappeared and the alarm can be manually acknowledged (if Class (A) or (B)).
Acknowledged	The alarm has been manually acknowledged (but the cause is still present).

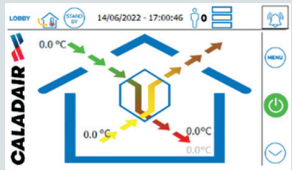
15.7. Active alarms

Access path to the function (Access level: Guest)	
	Step 1 → Step 2
From screen	
Area to click	
	

The “Active Alarms” menu allows the active alarms to be viewed.

An active alarm is an alarm where the activation condition is currently present but the cause has potentially disappeared.

15.8. Alarm history

Access path to the function (Access level: Guest)					
	Step 1	→	Step 2	→	Step 3
From screen					
Area to click					

The alarm history menu shows up to 100 alarm events recorded according to the FIFO (first in first out) principle. The 101st (most recent) event overwrites the oldest event.

Resetting the alarm buffer is not possible: the recorded alarms cannot be deleted.
The year in which the alarm occurred is not stored, only the month and day are shown.

For each alarm, the log records the day and time of occurrence, clearance and manual acknowledgement (if class A), which facilitates diagnosis and troubleshooting.

15.9. Alarm maintenance (filters)

Access path to the function (Access level: Guest)					
	Step 1	→	Step 2	→	Step 3
From screen					
Area to click					

By means of the maintenance alarm function (filters), it is possible to indicate via an alarm visible from the “Active alarms” or “Alarm history” page that the set maintenance interval has expired and that preventive maintenance is required on the filters or on other components, since this function can be used for more than just the filters.

One month corresponds to 30 days, and the countdown starts as soon as the unit is switched on.
When the power is off and the controller is not operating, the countdown is not implemented.

Example:

If a deadline of 12 months is set, the alarm will be activated after 12 months X 30 days/month = 360 days.
If the power supply to the unit has been cut off for a total of 3 days, the alarm will be activated after 363 days.
It is not possible to know the number of days remaining or to specify an anniversary date. This function must be activated during commissioning by setting an interval other than 0.

15.10. Alarm and fault table

Id	Description	Class	Time limit	Action	Value/threshold	Details/explanations	Possible causes
1	Supply air fan (VAS) fault	A	30s	Normal stop*	<p>ECO / DIVA: 25Pa (pressure switch setting)</p> <p>LOBBY: 25Pa (control system)</p> <p>MAC2/ QUATTRO: depends on the machine model (see table below)</p>	<p>ECO/DIVA: the fan operation feedback information from the pressure switch has not been received within the allotted time (30s), the machine stops, and a manual acknowledgement of the alarm is required to restart. The air pressure switch is type NO. It closes when the air pressure exceeds 25 Pa (factory setting).</p> <p>LOBBY: the air pressure transmitted by the pressure transducer did not exceed the minimum threshold (25Pa) within the time limit (30s). The minimum threshold is set at 25Pa in the control system.</p> <p>MAC2/QUATTRO: the air volume transmitted by the volume transducer did not exceed the minimum threshold within the time limit (30s). The minimum threshold depends on each machine model (see table below).</p>	<ul style="list-style-type: none"> • Faulty fan • Faulty fan power supply • Speed control signal problem (HS controller output, faulty wiring/connection between fan and controller, faulty controller AO output, etc.) • Moisture in the pressure tap tubes • Poorly connected, inverted or clogged pressure tap tubes • Fresh air register remains closed • Air distribution system: fire damper closed, duct obstructed. <p>ECO / DIVA specific:</p> <ul style="list-style-type: none"> • Faulty pressure switch • Pressure switch incorrectly set • Faulty wiring/connection between pressure switch and controller • Speed setpoint too low in relation to network pressure drop <p>LOBBY specific:</p> <ul style="list-style-type: none"> • Faulty pressure transducer • Faulty wiring/connection between pressure transducer and controller • Air distribution network not sufficiently resistant (machine not connected, machine undersized) <p>MAC2 / QUATTRO specific:</p> <ul style="list-style-type: none"> • Faulty volume transducer • Faulty wiring/connection between volume transducer and controller • Air distribution network too resistant (closed damper/register, undersized network, oversized unit) • Clogged or unsuitable air filter (too resistive)

Id	Description	Class	Time limit	Action	Value/threshold	Details/explanations	Possible causes
6	Return air fan (VAR) fault	A	120s	Normal stop*	See Id=1 supply air fan (VAS) fault	See Id=1 supply air fan (VAS) fault	See Id=1 supply air fan (VAS) fault
44	Rotary heat exchanger alarm	C	600s			<p>The operational feedback from the control-command box of the rotary heat exchanger was not received within the time limit.</p> <p>The machine continues to operate without energy recovery.</p>	<p>The wheel is blocked or has a mechanical rotational defect. The belt is broken or slipping. The drive motor has a malfunction. The run command (K2-wheel relay) or the power supply to the control-command box has a fault / malfunction. The control-command box of the rotary heat exchanger is defective.</p>
53	Supply and return filter alarm	C	600s			The pressure drop of the supply and/or return filters has exceeded the set value (300Pa for M5 + F7 filters, 200Pa for F7 filter, 150Pa for M5 filter) of the corresponding filter pressure switch.	<p>Clogged filter.</p> <p>Unsuitable filter (third-party supply does not meet manufacturer's requirements).</p> <p>Unsuitable filtration class.</p> <p>An external element obstructs the air flow in the machine.</p>
54	Return filter alarm	C	600s			See Id=53 Supply and return filter alarm	See Id=53 Supply and return filter alarm
56	Frost protection alarm (THA)	C	120s	Rapid stop**		<p>The frost protection thermostat (THA) has detected a hot water coil temperature below its set value (5°C factory setting). When the alarm is active, the unit stops immediately without a post-ventilation sequence and the hot water coil output is forced to 100% (10V); see details/explanations in the rest of the document (XXI.2 Frost protection thermostat (THA))</p>	<p>The hot water coil supply pump does not work (no air volume). The 3-way temperature control valve remains closed. The hot water generator is not working or supplies water that is too cold. The thermostat setting has been changed. The thermostat is faulty. The wiring/cable between the thermostat and the controller is faulty.</p>
58	Fire alarm	C	1s			<p>The behaviour of the machine depends on how the anti-fire function is configured by the user. When leaving the factory, the anti-fire function is not activated, so it is not functional. Depending on the settings made during commissioning, the activation of the anti-fire function can affect the operation of the unit, the fans, the isolation dampers and the bypass (if plate heat exchanger).</p>	The DI input is active (dry contact closed).

Id	Description	Class	Time limit	Action	Value/threshold	Details/explanations	Possible causes
60	External stop	C	1s			The DI digital input is active (dry contact closed). The machine is stopped as long as the contact is closed. This overrides the time settings.	
62	Maintenance stop	C	1s			The machine is switched OFF from the on/off button on the home page. The machine remains stopped until switching to ON is requested. This control has priority over the time settings and the BMS.	
63	Overheating of electric coil/ fresh air preheating coil	A	1s	Normal stop*		The THS thermostat has detected a temperature > 100°C at the electric heating coil. When the alarm is activated, the machine stops and goes through a post-ventilation process to cool the electric coil. The THS thermostat is of the NC (normally closed) type. It is necessary to reset the thermostat itself and manually acknowledge the alarm to restart the machine.	Lack/loss of supply air volume while the electrical coil was active (sudden fan malfunction, power cut, loss of fan power supply, etc.). Faulty static relay: a faulty static relay can become conductive, resulting in a permanent power supply to the electric coil.
78	Internal battery error	C	120s	Normal stop*		The charge level of the internal battery has reached the minimum threshold to ensure that the settings are retained in the event of a power failure.	The battery is defective and/or the controller is too old. It is necessary to replace the battery as soon as possible (CR2032 battery) in order not to lose the settings of the controller if there is a power failure.
79	Maintenance alarm	C	1			The set maintenance interval has been exceeded, preventive maintenance is necessary. The unit continues to function normally.	To deactivate the maintenance alarm, an interval of 0 months = factory setting must be set (see detailed description of the function)
82	Supply air fan difference alarm	C	30 mins		LOBBY: 50Pa MAC2/ QUATTRO: depends on the unit size, see table below	The measured air volume or the measured pressure has exceeded the threshold value beyond the specified time limit (30 mins). The threshold value is equal to the current setpoint +/- threshold value. LOBBY: (example: current setpoint = 120Pa) 70Pa < Pressure < 170Pa MAC2/QUATTRO: (example current setpoint = 1000 m3/h) 700m3/h < volume < 1300m3/h:	See alarm Id= 1 Supply air fan (VAS) fault

Id	Description	Class	Time limit	Action	Value/threshold	Details/explanations	Possible causes
83	Return air fan difference alarm	C	30 mins		LOBBY: 50Pa MAC2/ QUATTRO: depends on the unit size, see table below	The measured air volume or the measured pressure has exceeded the threshold value beyond the specified time limit (30 mins). The threshold value is equal to the current setpoint +/- threshold value. LOBBY: (example: current setpoint = 120Pa) 70Pa < Pressure < 170Pa MAC2/QUATTRO: (example current setpoint = 1000 m ³ /h) 700m ³ /h < volume flow < 1300m ³ /h	See alarm Id= 6 Return air fan (VAR) fault
86	Supply temperature too high	A	5s	Normal stop*	55°C	The supply air volume has become far too low in relation to the power supplied by the heating coil. The unit stops when the alarm is triggered. To restart, the temperature must fall below 55°C and the alarm must be manually acknowledged.	Supply air fan VAS defective. The unit's isolation damper and the network dampers remain closed. Static relay for electric coil control is defective.
113	Operation in manual mode	C	1s			This alarm does not stop the unit but it is necessary to stop the unit to switch the outputs to manual mode. In order to restart the unit, all outputs must be in auto mode.	
115	Supply air fan in manual mode	C	1s				
116	Return air fan in manual mode	C	1s				The corresponding actuator is under manual control.
117	Heating coil in manual mode	C	1s				
118	Exchanger in manual mode	C	1s				
119	Cooling coil in manual mode	C	1s				
125	Motorised fresh air isolation damper in manual mode	C	1s				The corresponding actuator is under manual control.
126	Motorised exhaust air isolation damper in manual mode	C	1s				

Id	Description	Class	Time limit	Action	Value/threshold	Details/explanations	Possible causes
138	Output in manual mode	C	1s				At least one output is in manual mode. This alarm works in conjunction with alarms 113/115/116/117/118/119/125/126/140. This also indicates that the heating and/or cooling outputs have been switched to manual mode.
140	Fresh air preheating coil in manual mode	C	1s				The fresh air preheating coil is under manual control.
145	Outside air temperature sensor fault	A	5s	Normal stop*			Faulty temperature sensor and/or wiring (open or short circuit)
146	Supply air temperature sensor fault	A	5s	Normal stop*			
147	Exhaust air temperature sensor fault (bypass)	A	5s	Normal stop*		Only if plate heat exchanger For the anti-icing function of the plate heat exchanger via bypass	
148	Return air temperature sensor fault	A	5s	Normal stop*			
165	Supply pressure transducer fault	A	5s	Normal stop*		Only for LOBBY	Faulty/missing transducer and/or faulty wiring (open or short circuit)
166	Return pressure transducer fault	A	5s	Normal stop*		Only for LOBBY	Faulty/missing transducer and/or faulty wiring (open or short circuit)
167	Supply air volume transducer fault	A	5s	Normal stop*		MAC2 / QUATTRO only	Faulty/missing transducer and/or faulty wiring (open or short circuit)
168	Return air volume transducer fault	A	5s	Normal stop*		MAC2 / QUATTRO only	Faulty/missing transducer and/or faulty wiring (open or short circuit)
175	CO2 transducer fault	A	5s	Normal stop*		DIVA and QUATTRO only	Faulty/missing transducer and/or faulty wiring (open or short circuit)
179	Fresh air preheating temperature sensor fault	A	5s	Normal stop*		Plate heat exchanger units only	Faulty/missing temperature sensor and/or wiring (open or short-circuited) when the unit is equipped with a fresh air preheating coil (INFINITE). Faulty or missing 1000 Ohm resistor at the controller terminals when the unit is not equipped with a fresh air preheating coil.
192	Communication fault with the slave controller	C	120s				Incorrectly configured master or slave controller, missing or faulty wire connection between the two controllers, faulty/non-functional slave controller.

Id	Description	Class	Time limit	Action	Value/threshold	Details/explanations	Possible causes
193	Faulty fresh air preheating control loop	C	5s				Incorrect setting of the function
194	Internal control system fault	A	5s	Normal stop*			Incorrect internal settings of the CLD-283 controller

*Normal stop = shutdown including post-ventilation

**Rapid stop = no post-ventilation, all outputs are deactivated instantaneously when the fault occurs.

15.11. Fan feedback and difference thresholds

Machine (MAC2 or QUATTRO)	Reduced operation volume	Reduced operation volume	S + R fans return threshold	S + R fan difference threshold
CARMA 9010	400 m ³ /h	800 m ³ /h	300 m ³ /h	240 m ³ /h
CARMA 9016 / SILVERTOP 15	800 m ³ /h	1200 m ³ /h	300 m ³ /h	360 m ³ /h
CARMA 9023 / SILVERTOP 23	1000 m ³ /h	1800 m ³ /h	350 m ³ /h	540 m ³ /h
CARMA 9035 / SILVERTOP 35	1700 m ³ /h	3000 m ³ /h	610 m ³ /h	900 m ³ /h
CARMA 9048	2000 m ³ /h	3500 m ³ /h	770 m ³ /h	1050 m ³ /h
SILVERTOP 52	2750 m ³ /h	3900 m ³ /h	740 m ³ /h	1170 m ³ /h
CARMA 9070	3000 m ³ /h	5800 m ³ /h	1200 m ³ /h	1740 m ³ /h
NEOTIME 600	250 m ³ /h	500 m ³ /h	155 m ³ /h	150 m ³ /h
NEOTIME 900	350 m ³ /h	700 m ³ /h	225 m ³ /h	210 m ³ /h
NEOTIME 1300	550 m ³ /h	1100 m ³ /h	500 m ³ /h	330 m ³ /h
NEOTIME 1800	750 m ³ /h	1500 m ³ /h	550 m ³ /h	450 m ³ /h
NEOTIME 2500	1000 m ³ /h	2000 m ³ /h	650 m ³ /h	600 m ³ /h
FREETIME 1500/ HEXAMOTION 15	700 m ³ /h	1000 m ³ /h	300 m ³ /h	300 m ³ /h
FREETIME 2000/ HEXAMOTION 20	1000 m ³ /h	1400 m ³ /h	350 m ³ /h	420 m ³ /h
FREETIME 2500 / HEXAMOTION 27	1750 m ³ /h	2400 m ³ /h	580 m ³ /h	720 m ³ /h
FREETIME 3500 / HEXAMOTION 35	2000 m ³ /h	3000 m ³ /h	580 m ³ /h	900 m ³ /h
HEXAMOTION 45	2750 m ³ /h	3900 m ³ /h	740 m ³ /h	1170 m ³ /h
HEXAMOTION 60	3250 m ³ /h	4600 m ³ /h	770 m ³ /h	1380 m ³ /h
HEXAMOTION 80	4200 m ³ /h	6000 m ³ /h	1200 m ³ /h	1800 m ³ /h

15.12. Frost protection alarm details

When the frost protection alarm is active, this means that the temperature of the frost protection thermostat bulb attached to the hot water heating coil has fallen below +5°C (factory setting) and that there is a risk of the heating coil freezing up when filled with primary water (without MEG/MPG anti-freeze additive). The ventilation is stopped immediately (quick stop), there is no post ventilation, and the heating coil output is forced to 100% in order to open the 3-way valve for the heating coil water supply to a maximum and thus raise the temperature as quickly as possible. When the thermostat bulb temperature rises above +5°C, the unit restarts automatically (class C alarm = automatic acknowledgement) and the position signal of the 3-way valve returns to the value calculated by the PID of the heating sequence.

16. BMS communication

16.1. General

The controller has the following 2 external communication ports:

- Port P1: Modbus RTU RS485 (slave) or Bacnet MS/TP
- TCP-IP port: Modbus TCP or Bacnet IP or web server

When a communication is active on a port, the corresponding green status LED flashes:

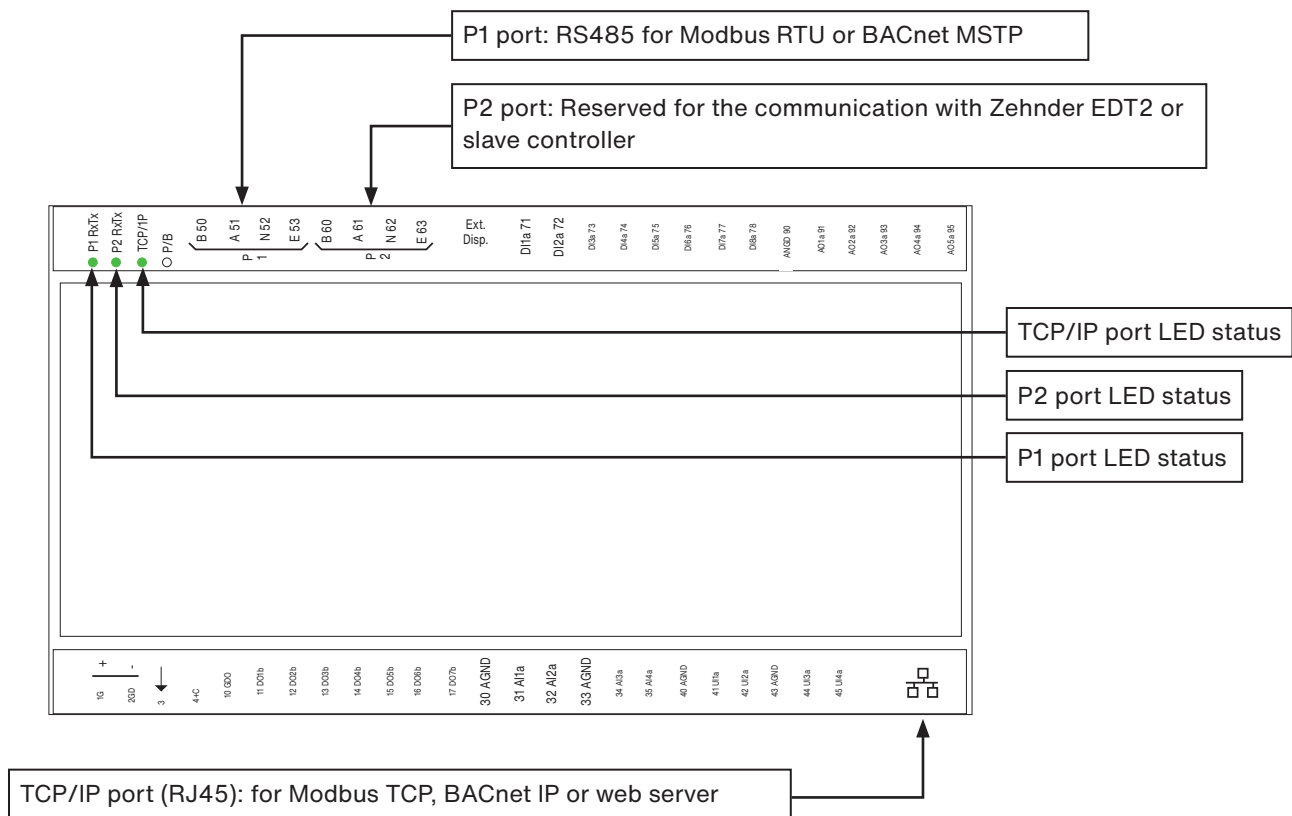

When a network search is performed to identify the controller, it appears as “CALADAIR AHU” and model “CLD-283-WEB-5.0”.

16.2. Modbus RTU RS485 communication

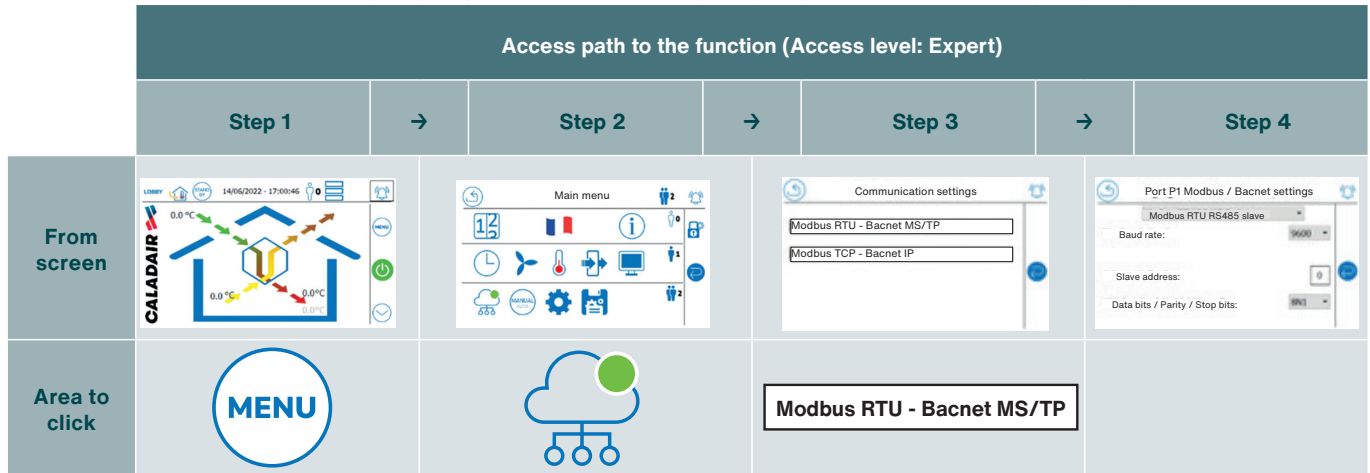

Functions supported by the Modbus protocol implemented in the controller:

Supported function	Coil Status Register	Input Status Register	Holding Register	Input Register
1 / Read Coils	✓			
2 / Read Discrete Input		✓		
3 / Read Holding Register			✓	
4 / Read Input Register				✓
5 / Write Single Coil	✓			
6 / Write Single Register			✓	
15 / Write Multiple Coils	✓			
16 / Write Multiple Registers			✓	

By default, the slave address of the controller is set to (1) ex factory. The address can be set between 1 and 247. Each controller on the Modbus network must have a different address from the others.

The data transmission mode is RTU (Remote Terminal Unit) (not ASCII) with a word length of 8 bits.

A maximum of 47 registers can be read in a single message.

The master controller requires a silent interval of 3.5 characters (4ms at 9600 baud) between two messages. If there are several slave controllers on the same communication line, the master controller requires a minimum silent interval of 14 characters (16ms at 9600 baud) between the last controller response and the first question from the next controller.

Parameter	Possible value range
Baud rate	9600/14400/19200/28800/38400/57600/76800/115200
Address (slave)	1...247
Number of data bits	8
Parity	None/Even/Odds
Number of stop bits	1/ 2

16.3. Modbus TCP communication

Access path to the function (Access level: Expert)							
	Step 1	→	Step 2	→	Step 3	→	Step 4
From screen							
Area to click					Modbus TCP - Bacnet IP		Protocol: Modbus TCP

Activating communication via the Modbus TCP protocol requires the following parameters to be set manually if the DHCP is not enabled:

IP Address	192,033,050,112
Gateway	192,033,050,005
DNS	192,033,050,040
Subnet mask	255,255,255,000

If the DHCP is activated (factory setting), these parameters are assigned directly by the network when the TCP-IP port is connected (see II PHYSICAL PRESENTATION OF THE CLD-283 CONTROLLER).

16.4. Bacnet MS/TP and Bacnet IP communication

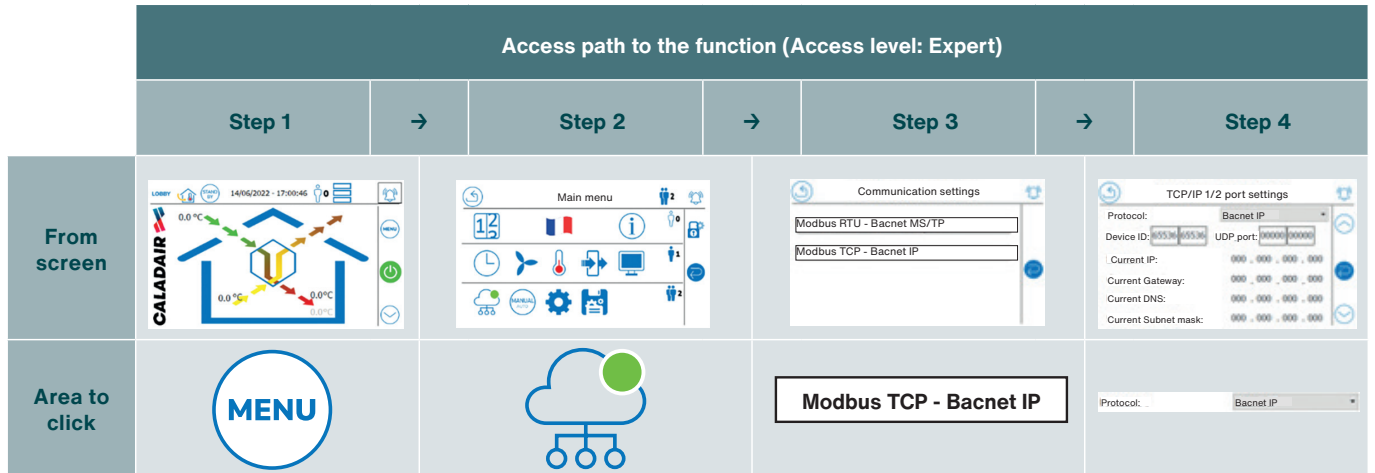

Only one Bacnet communication is possible: if both the IP Bacnet and the MSTP Bacnet are enabled, only the IP Bacnet will be functional because it has priority. For the MSTP Bacnet to work, the IP Bacnet must be disabled.

In Bacnet, the list of variables is linked to the configuration of the unit. For example, if the temperature control is in constant supply, the air law variables are not accessible. If the unit is in pressure control (LOBBY), the air volume variables (MAC2) are not accessible.

The functions supported by the controller are as follows:

Supported functions	Type*
Read and write binary value (BV)	10XXX
Read binary value (BV)	20XXX
Read and write analogue value (AV)	30XXX
Read analogue value (AV)	40XXX
Read and write multistate value (MSV)	30XXX
Read multistate value (MSV)	40XXX

	BACnet IP	BACnet MS/TP (RS485)	Details
Speed		X	9600/14400/19200/28800/38400/57600/76800/115200 bauds
Device ID	X	X	It is made up of 2 parts, the bottom Device ID and the top Device ID, which are concatenated to form the complete Device ID. Top Device ID (01234) + Bottom Device ID (56789) = Device ID (0123456789)
Device Name	X	X	“Corrigo 5.0” Neither viewable nor configurable from the screen. Use the integrated web server.
UDP port number	X		This is the dedicated communication port. It is made up of 2 parts, the bottom UDP and the top UDP, which are concatenated to form the complete Device ID: Top UDP (01234) + Bottom UDP (56789) = UDP (0123456789)
BBMD	X	X	A Bacnet Broadcast Management Device is used to detect controllers that are attached to different Bacnet IP subnets and separated by an IP router. Neither viewable nor configurable from the screen. Use the integrated web server.
Max Master Device		X	This is the address of the highest Bacnet MS/TP device on the network. Setting this value below the highest value actually present on the network will result in a loss of communication performance.
MAC Address		X	Mac address of the controller, which must be unique on the subnetwork to which it is attached.
DHCP	X		A Dynamic Host Configuration Protocol is a network protocol that automatically configures the IP settings of a station or machine, including automatically assigning an IP address and subnet mask (see XVI.5 IP Configuration (DHCP)).

16.5. IP configuration (DHCP)

A DHCP (Dynamic Host Configuration Protocol) is a network protocol used on Internet Protocol (IP) networks for the dynamic distribution of network configuration parameters, such as IP addresses, DNS servers and other services.

The controller can be configured to obtain its IP address in two ways:

- Either from a DHCP server (dynamic addressing)
- Or manually by filling in the information directly from the screen (static address). This information must be identified beforehand.

IP configuration is required for both protocols:

- BACnet IP
- Modbus TCP

By default, the controller is set up with DHCP active. The address is therefore automatically assigned by the network.

IP	192,033,050,112
Gateway	192,033,050,005
DNS	192,033,050,040
Subnet mask	255,255,255,000

The static setting must be changed manually if the DHCP is not activated.

16.6. Modbus and BACnet exchange tables

The Modbus addresses shown in the tables use the generic Modbus standard. There is no address offset to be expected, the 1st existing variable is addressed to the value 0 (not 1).

Scaling factor = 10 means that the value read must be divided by 10 to be converted into a real value.

Example: if the value read in the supply temperature variable is 230, this means that the temperature value is $230 / 10 = 23.0^{\circ}\text{C}$.

It is not possible to acknowledge alarms via the communication. Acknowledgement must be done manually in person directly on the machine's PG 5.0 touchscreen after the cause of the problem has been identified and resolved.

The setpoints sent by the communication have priority over all the other setpoints (external and internal) except for the on/off command of the screen which has absolute priority: if the local command is off, the unit cannot start even if the BMS requests it. Therefore, the control must be on in order for the BMS to work.

16.6.1. Machine status

	Unit	Reading	Entry	Scaling factor Modbus	Function Modbus	Address Modbus	Variable type Modbus	Address BACnet	Details
Current status of the unit		X		1	Input Register	428	short	MSV, 30789	Modbus: 0=Stop/1=start 2=reduced operation/ 3=normal operation/ 7=CO ₂ management/8=Free Cooling/9=post-ventilation 10=Fire/13=frost protection BACnet: 1=Stop/2=start/ 3=reduced operation/ 4=normal operation/ 8=CO ₂ management/9=Free Cooling/ 10=post-ventilation/ 11=Fire/ 14=frost protection
Outdoor temperature (fresh air)	°C	X		10	Input Register	291	short	AV,40291	
Supply temperature	°C	X		10	Input Register	292	short	AV, 40292	
Return temperature	°C	X		10	Input Register	294	short	AV, 40294	
Exhaust temperature (bypass)	°C	X		10	Input Register	293	short	AV, 40293	Only if plate heat exchanger
Preheated air temperature	°C	X		10	Input Register	325	short	AV, 40325	Only if plate heat exchanger
Supply air fan speed	%	X		1	Input Register	465	short	AV, 40375	Only for ECO and DIVA versions
Return air fan speed	%	X		1	Input Register	466	short	AV, 40376	Only for ECO and DIVA versions
Supply air fan pressure	Pa	X		10	Input Register	311	short	AV, 40311	Only for LOBBY versions
Return air fan pressure	Pa	X		10	Input Register	312	short	AV, 40312	Only for LOBBY versions
Supply air fan volume	m ³ /h	X		0.1	Input Register	313	short	AV, 40313	Only for MAC2 and QUATTRO versions
Return air fan volume	m ³ /h	X		0.1	Input Register	314	short	AV, 40314	Only for MAC2 and QUATTRO versions
CO ₂ rate	ppm	X		1	Input Register	321	short	AV, 40321	Only for DIVA and QUATTRO versions
Operating time of supply air fan	hours	X		10	Input Register	434	short	AV, 40434	
Operating time of return air fan	hours	X		10	Input Register	435	short	AV, 40435	
Heating analogue/digital output	%	X		10	Input Register	1014	short	AV, 40363	0%=0V 100%=10V / 0%=0% PWM 100%=100% PWM
Analogue recovery unit output/bypass	%	X		10	Input Register	1015	short	AV, 40634	Rotary heat exchanger or bypass plate heat exchanger 0%=0V 100%=10V
Analogue cooling output	%	X		10	Input Register	1016	short	AV, 40365	0%=0V 100%=10V
Supply air fan analogue output	%	X		10	Input Register	375	short	AV, 40375	0%=0V 100%=10V
Return air fan analogue output	%	X		10	Input Register	376	short	AV, 40376	0%=0V 100%=10V

16.6.2. Setpoints

	Unit	Reading	Entry	Scaling factor Modbus	Factory setting Modbus	Type Register Modbus	Address Modbus	Variable Modbus	Address BACnet	Details
Setpoint of operating mode	-	X	X	1	0	Holding Register	796	short	MSV, 30796	Modbus: 0=Inactive/1=reduced operation/ 2=normal operation/ 4=AHU stop BACnet: 1=Inactive/2=reduced operation/ 3=normal operation/ 5=AHU stop
Constant supply temperature setpoint	°C	X	X	10	180	Holding Register	811	short	AV,30811	Used only if temperature control of constant supply
Constant return temperature setpoint	°C	X	X	10	180	Holding Register	812	short	AV, 30812	Used only if temperature control of constant return
Outdoor temperature 1 air law	°C	X	X	10	-200	Holding Register	817	short	AV, 30817	Used only if temperature control (supply or return) by air law
Outdoor temperature 2 air law	°C	X	X	10	-50	Holding Register	818	short	AV, 30818	Used only if temperature control (supply or return) by air law
Outdoor temperature 3 air law	°C	X	X	10	100	Holding Register	819	short	AV, 30819	Used only if temperature control (supply or return) by air law
Outdoor temperature 4 air law	°C	X	X	10	150	Holding Register	820	short	AV, 30820	Used only if temperature control (supply or return) by air law
Outdoor temperature 5 air law	°C	X	X	10	200	Holding Register	821	short	AV, 30821	Used only if temperature control (supply or return) by air law
Outdoor temperature 6 air law	°C	X	X	10	250	Holding Register	822	short	AV, 30822	Used only if temperature control (supply or return) by air law
Outdoor temperature 7 air law	°C	X	X	10	350	Holding Register	823	short	AV, 30823	Used only if temperature control (supply or return) by air law
Outdoor temperature 8 air law	°C	X	X	10	400	Holding Register	824	short	AV, 30824	Used only if temperature control (supply or return) by air law
Air law temperature setpoint external temperature 1	°C	X	X	10	250	Holding Register	825	short	AV, 30825	Used only if temperature control (supply or return) by air law
Air law temperature setpoint external temperature 2	°C	X	X	10	230	Holding Register	826	short	AV, 30826	Used only if temperature control (supply or return) by air law
Air law temperature setpoint external temperature 3	°C	X	X	10	200	Holding Register	827	short	AV, 30827	Used only if temperature control (supply or return) by air law

	Unit	Reading	Entry	Scaling factor Modbus	Factory setting Modbus	Type Register Modbus	Address Modbus	Variable Modbus	Address BACnet	Details
Air law temperature setpoint external temperature 4	°C	X	X	10	190	Holding Register	828	short	AV, 30828	Used only if temperature control (supply or return) by air law
Air law temperature setpoint external temperature 5	°C	X	X	10	180	Holding Register	829	short	AV, 30829	Used only if temperature control (supply or return) by air law
Air law temperature setpoint external temperature 6	°C	X	X	10	180	Holding Register	830	short	AV, 30830	Used only if temperature control (supply or return) by air law
Air law temperature setpoint external temperature 7	°C	X	X	10	230	Holding Register	831	short	AV, 30831	Used only if temperature control (supply or return) by air law
Air law temperature setpoint external temperature 8	°C	X	X	10	230	Holding Register	832	short	AV, 30832	Used only if temperature control (supply or return) by air law
Supply air fan normal speed setpoint	%	X	X	10	70	Holding Register	848	short	AV, 30848	Only for ECO and DIVA versions
Supply air fan reduced speed setpoint	%	X	X	10	40	Holding Register	847	short	AV, 30847	Only for ECO and DIVA versions
Return air fan normal speed setpoint	%	X	X	10	70	Holding Register	851	short	AV, 30851	Only for ECO and DIVA versions
Return air fan reduced speed setpoint	%	X	X	10	40	Holding Register	850	short	AV, 30850	Only for ECO and DIVA versions
Supply air fan normal pressure setpoint	Pa	X	X	10	130	Holding Register	836	short	AV, 30836	Only for LOBBY versions
Supply air fan reduced pressure setpoint	Pa	X	X	10	130	Holding Register	835	short	AV, 30835	Only for LOBBY versions
Return air fan normal pressure setpoint	Pa	X	X	10	130	Holding Register	839	short	AV, 30839	Only for LOBBY versions
Return air fan reduced pressure setpoint	Pa	X	X	10	130	Holding Register	838	short	AV, 30838	Only for LOBBY versions
Supply air fan normal air volume setpoint	m ³ /h	X	X	0.1	See details	Holding Register	842	short	AV, 30842	Only for MAC2 and QUATTRO versions, factory setting depends on machine model
Supply air fan reduced air volume setpoint	m ³ /h	X	X	0.1	See details	Holding Register	841	short	AV, 30841	Only for MAC2 and QUATTRO versions, factory setting depends on machine model
Return air fan normal air volume setpoint	m ³ /h	X	X	0.1	See details	Holding Register	845	short	AV, 30845	Only for MAC2 and QUATTRO versions, factory setting depends on machine model

	Unit	Reading	Entry	Scaling factor Modbus	Factory setting Modbus	Type Register Modbus	Address Modbus	Variable Modbus	Address BACnet	Details
Setpoint 1 CO ₂	ppm	X	X	1	800	Holding Register	1036	short	MSV, 31036	Only for DIVA and QUATTRO versions
Setpoint 2 CO ₂	ppm	X	X	1	900	Holding Register	1038	short	AV,31038	Only for DIVA and QUATTRO versions
Setpoint 3 CO ₂	ppm	X	X	1	1000	Holding Register	1040	short	AV, 31040	Only for DIVA and QUATTRO versions
Fan balancing 1 CO ₂	%	X	X	1	0%	Holding Register	1037	short	AV, 31037	Only for DIVA versions
Fan balancing 2 CO ₂	%	X	X	1	15%	Holding Register	1039	short	AV, 31039	Only for DIVA versions
Fan balancing 3 CO ₂	%	X	X	1	30%	Holding Register	1041	short	AV, 31041	Only for DIVA versions
Fan balancing 1 CO ₂	m ³ /h	X	X	0.1	See details	Holding Register	1037	short	AV, 31037	Only for QUATTRO versions, factory setting depends on machine model
Fan balancing 2 CO ₂	m ³ /h	X	X	0.1	See details	Holding Register	1039	short	AV, 31039	Only for QUATTRO versions, factory setting depends on machine model
Fan balancing 3 CO ₂	m ³ /h	X	X	0.1	See details	Holding Register	1041	short	AV, 31041	Only for QUATTRO versions, factory setting depends on machine model

16.6.3. Faults and alarms

	Reading	Entry	Type Register Modbus	Address Modbus	Variable Modbus	Address BACnet	Details
Alarm presence A/B/C	X		Input Status	7	bool	BV, 20007	0=no alarm / 1=at least one alarm present
Class A alarm presence	X		Input Status	8	bool	BV, 20008	0=no alarm / 1=alarm present
Class B alarm presence	X		Input Status	9	bool	BV, 20009	0=no alarm / 1=alarm present
Class C alarm presence	X		Input Status	10	bool	BV, 20010	0=no alarm / 1=alarm present
Supply air fan fault	X		Input Status	11	bool	BV, 20011	0=no alarm / 1=alarm present
Return air fan fault	X		Input Status	16	bool	BV, 20016	0=no alarm / 1=alarm present
Supply/return filter fault	X		Input Status	63	bool	BV, 20063	0=no alarm / 1=alarm present
Internal battery fault	X		Input Status	88	bool	BV, 20088	0=no alarm / 1=alarm present
Electric coil overheating fault	X		Input Status	73	bool	BV, 20073	0=no alarm / 1=alarm present Only for machine equipped with an electric heating coil

	Reading	Entry	Type Register Modbus	Address Modbus	Variable Modbus	Address BACnet	Details
Hot water coil frost protection fault	X		Input Status	66	bool	BV, 20066	0=no alarm / 1=alarm present Only for machine equipped with a hot water heating coil
Rotary heat exchanger fault	X		Input Status	54	bool	BV, 20054	0=no alarm / 1=alarm present Only for machine equipped with rotary heat exchanger
Fresh air temperature sensor fault	X		Input Status	154	bool	BV, 20154	0=no alarm / 1=alarm present
Supply air temperature sensor fault	X		Input Status	156	bool	BV, 20156	0=no alarm / 1=alarm present
Exhaust air temperature sensor fault	X		Input Status	157	bool	BV, 20157	0=no alarm / 1=alarm present Only for machine equipped with plate heat exchanger
Return air temperature sensor fault	X		Input Status	158	bool	BV, 20158	0=no alarm / 1=alarm present
Preheated air temperature sensor fault	X		Input Status	191	bool	BV, 20191	0=no alarm / 1=alarm present Only for machine equipped with plate heat exchanger
Supply pressure transducer fault	X		Input Status	175	bool	BV, 20175	0=no alarm / 1=alarm present
Return pressure transducer fault	X		Input Status	176	bool	BV, 20176	0=no alarm / 1=alarm present
Supply air volume transducer fault	X		Input Status	177	bool	BV, 20177	0=no alarm / 1=alarm present
Return volume transducer fault	X		Input Status	178	bool	BV, 20178	0=no alarm / 1=alarm present
CO ₂ transducer fault	X		Input Status	185	bool	BV, 20185	0=no alarm / 1=alarm present Only for DIVA and QUATTRO versions
Anti-fire fault	X		Input Status	68	bool	BV, 20068	0=no alarm / 1=alarm present
Manual mode output fault	X		Input Status	148	bool	BV, 20148	0=no alarm / 1=alarm present
Supply air fan difference	X		Input Status	92	bool	BV, 20092	0=no alarm / 1=alarm present
Return air fan difference	X		Input Status	93	bool	BV, 20093	0=no alarm / 1=alarm present
Supply temperature too high	X		Input Status	96	bool	BV, 20096	0=no alarm / 1=alarm present

17. On-board web server

The CLD-283 electronic controller has an on-board web server that now runs on HTML5, replacing JAVA which is no longer supported. It can be accessed via any recent Internet browser (download the add-ons if necessary or update the Internet browser used).

User level	PIN code
Admin	1111
Service	2222
Operator	3333
Normal	5555

The web server is accessed by simply typing the IP address of the controller in the search bar of the chosen Internet browser:

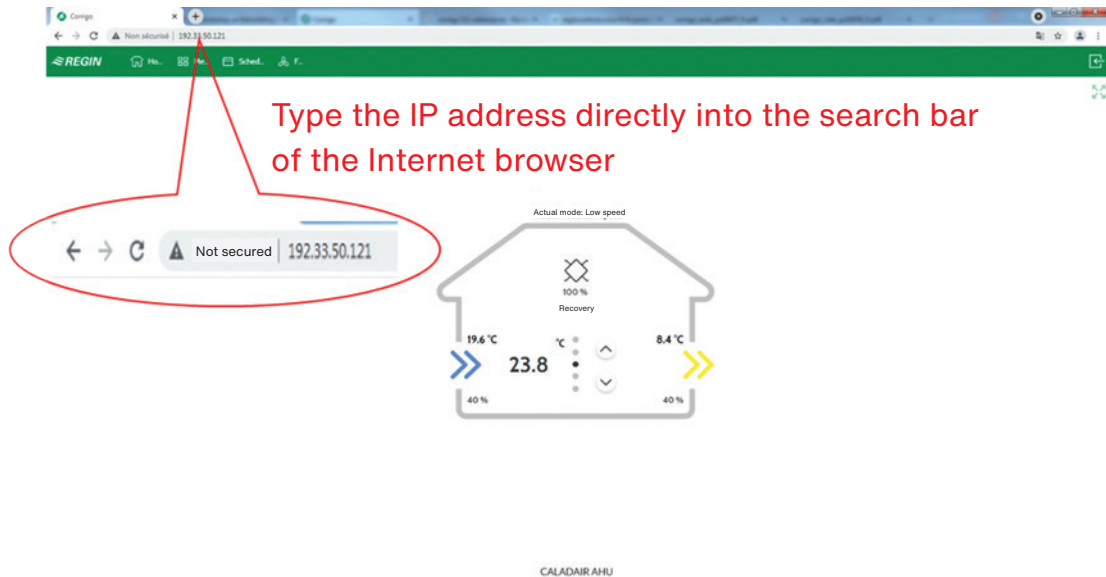

The IP address can be retrieved directly from the PG 5.0 touchscreen from the “communication” menu, see XVI.5 IP configuration (DHCP).

18. Temperature control modes

Access path to the function (Access level: Expert)							
	Step 1	→	Step 2	→	Step 3	→	Step 4
From screen							
Area to click							

18.1. Selection of temperature control mode

The controller has 4 different temperature control modes:

- Constant supply temperature
- Variable supply air temperature depending on the outdoor temperature (supply air law)
- Constant return temperature
- Variable return air temperature depending on the outdoor temperature (return air law)

When delivered, the machines are regulated according to the supply air law.

The selection of temperature control mode depends on several factors:

- Presence of a heating and/or cooling system in the building
- Presence of heating and/or cooling coils (integrated or not) for supply air, controlled by the
- integrated regulation of the ventilation unit
- Type of building occupancy (constant or variable)
- The level of comfort expected by the occupants

The presence of several devices that provide both heating and/or cooling in a building is often complex to set up because of the different zones to be managed, the different dynamics and response times of the systems, the different setpoint adjustment options, the different operating and control principles and the absence of a single measurand (each machine has its own measurand). In many cases, the systems operate independently of each other in an open loop, and there is no central system that manages and monitors all the different generators collectively.

It will be ensured that the ventilation unit:

- Recovers as much energy as possible and does not blow cold air in winter (or in cold periods) so that the main heating system is not overloaded and runs unnecessarily, causing needless energy consumption.
- Recovers maximum energy and does not blow hot air in summer (or hot weather) so that the main cooling system is not overloaded and runs unnecessarily, causing needless energy consumption.
- Uses a maximum of free energy (free cooling or free heating) from the outside air in the off-season.

Temperature control on the return air (constant or air law) is not recommended when a heating and/or cooling system other than the ventilation unit can cover all or most of these needs. Supply air temperature control (constant or air law) is preferred. It is assumed that in this case, the ventilation unit (if equipped with heating and/or cooling coils) only provides air supply at a temperature close to the setpoint, avoiding any user discomfort (feeling of hot or cold air). The supply air temperature setpoint must always be:

- Higher than the master system in cold periods (heating)
- Lower than the master system in hot periods (cooling)

The air law function makes it possible to meet these requirements as closely as possible, regardless of the outside temperature and therefore the time of year. If necessary, adjust the temperature setpoint (factory setting 18°C) of the night cooling function.

If a BMS or an external centralised control system managing the different systems is used, it will be possible via Modbus or Bacnet communication, for example, to manage the supply air setpoint by adding an offset (or not) of a few degrees in heating mode and vice versa in cooling mode in relation to the setpoint of the main system, thus allowing only a minimum amount of energy to be supplied while maintaining the comfort of the occupants close to the supply air outlets. Another solution is to recover the type of requirement (heating/cooling/neutral zone) from the main heating/cooling system and calculate the supply temperature setpoint from the return temperature measurement to which a constant or variable offset is added.

If the ventilation unit needs to provide the heating/cooling of the building on its own (in the case of new buildings), the unit must be equipped with the corresponding coils or must control remote coils in the ducts. In this case, it is preferable to regulate the temperature on the air return (extraction), which reflects the indoor conditions of the building, in particular with an air law based on the outdoor temperature. The control of the coils and the remote generators is done via the 2 analogue and 2 digital outputs provided on the controller embedded in the unit, namely:

- 0-10V output for heating needs used according to the configuration:
 - 3-way valve opening setpoint for heating
 - Heating generator heat requirement setpoint
- 0-10V output for cooling needs used according to the configuration:
 - 3-way valve opening setpoint for cooling
 - Cooling generator cold requirement setpoint
- On/ Off output for heating needs (24V AC to be relayed) used according to the configuration:
 - Authorisation to run the heating generator
 - Authorisation to run the circulator or heating pump (no degumming cycle)
- On/ Off output for cooling needs (24V AC to be relayed) used according to the configuration:
 - Authorisation to run the cooling generator
 - Authorisation to run the circulator cooling pump (no degumming cycle)

Whatever the temperature control method, performance and comfort are conditioned by the quality of the air network (air density, thermal insulation, distribution, balancing, diffusion).

18.2. Constant supply temperature

The constant supply temperature control can be identified by the pictogram in the “operating mode” area of the home page.

This mode of temperature control is the simplest to implement and adjust. It helps to ensure that the unit is compatible with any main heating/cooling system which alone meets the comfort requirements of the occupants.

There is only one setpoint to set.

The setpoint is set to 18°C in the factory and can be changed from +12°C to 40°C.

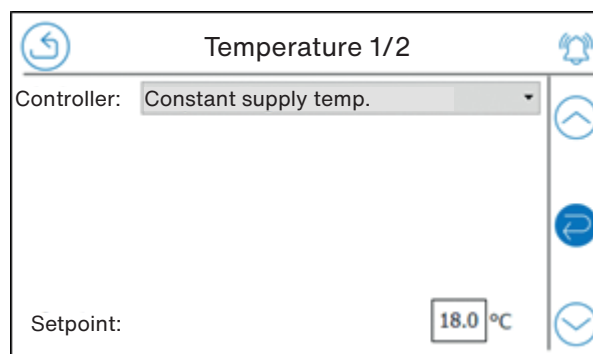

18.3. Supply air temperature in relation to the outdoor temperature (supply air law)

The supply air temperature control can be identified by the pictogram in the “operating mode” area of the home page.

In addition to the constant supply air temperature control mode, this temperature control mode allows the effects of outdoor temperature conditions to be incorporated into the performance of the building. This helps to improve comfort and minimise energy consumption.

The air law is fully adjustable from a pair of 8 outside temperature / supply temperature points. The predefined factory settings are to be adjusted according to the actual heat loss and performance of the building.

Please note that the controller uses the same temperature setpoint variables whether it is using supply air law or return air law. Switching from supply air to return air (or vice versa) therefore requires the setpoint to be adjusted for each outdoor temperature point. The setpoints are adjusted at the factory for a supply air law:

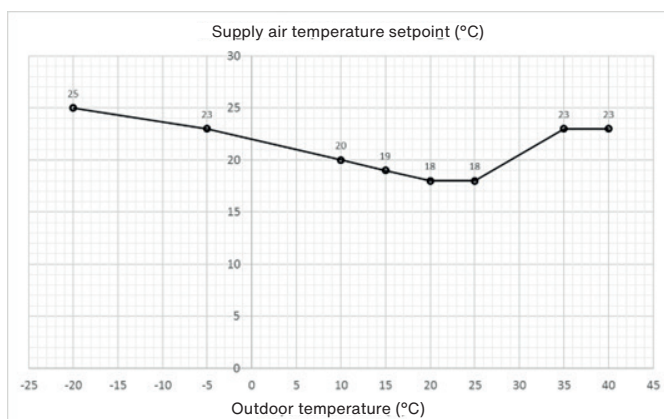
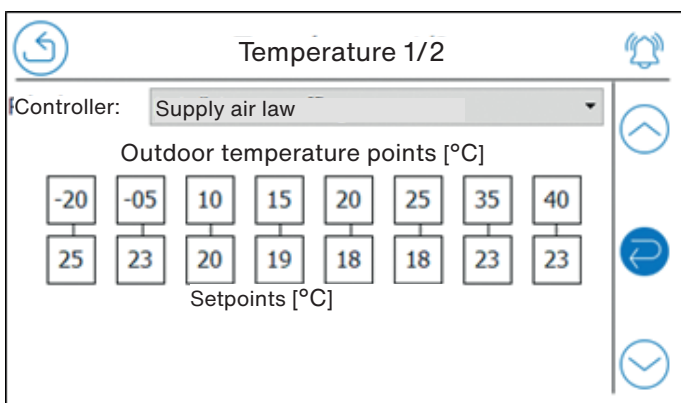

To avoid excessive energy consumption while maintaining acceptable comfort, it may be possible to raise the temperature setpoint for high outdoor temperatures.

18.4. Supply air temperature in relation to the outdoor temperature (supply air law)

The constant return temperature control can be identified by the pictogram in the “operating mode” area of the home page.

A constant return temperature control is preferred when the ventilation unit alone, or to a large extent, controls the thermal conditions in the building that it ventilates and when the internal conditions in the building fluctuate, for example, due to the occupancy level. It provides closed-loop control of the building's internal thermal conditions.

The setpoint is set to 18°C in the factory and can be changed from +12°C to 40°C.

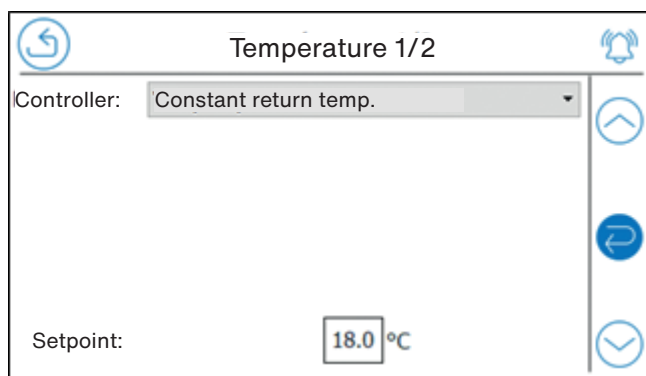

18.5. Return air temperature depending on the outdoor temperature (return air law)

The temperature control using air law can be identified by the presence of the pictogram in the “operating mode” area of the home page.

This temperature control mode has the same characteristics as the constant return temperature control mode, but it also allows the influence of outdoor temperature conditions on the behaviour of the building to be taken into account, thus further improving comfort while minimising energy consumption: the effects of cold walls in winter and solar radiation in summer are thus minimised.

The air volume law is fully adjustable from a pair of 8 outdoor temperature/return temperature points.

Please note that the controller uses the same temperature setpoint variables whether it is using supply air law or return air law. Switching from supply air to return air (or vice versa) therefore requires the setpoint to be adjusted for each outdoor temperature point. The setpoints are adapted at the factory for a supply air law and we can, for example, propose the (red) return air law curve below to be adapted according to the real characteristics and performance of the building:

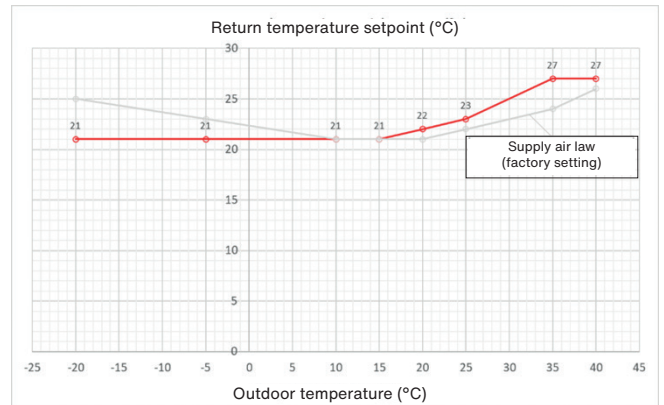
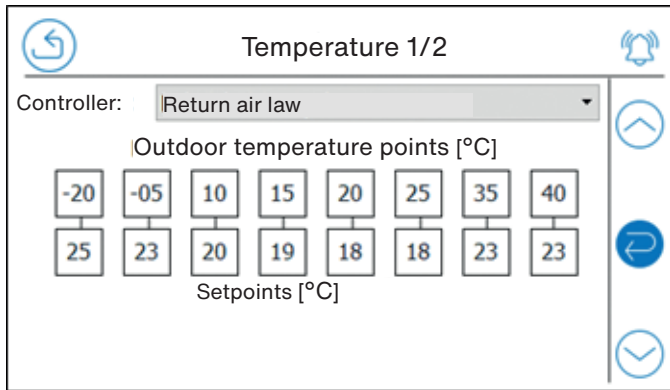

19. Fan control modes

Access path to the function (Access level: Guest)					
	Step 1	→	Step 2	→	Step 3
From screen					
Area to click					

19.1. General

For all machine versions, the speed of the fans is controlled via an analogue 0-10V control signal directly from the controller.

The fans start at a control voltage of 1V (minimum speed) and stop at a voltage below 1V. The maximum speed is achieved when the control voltage = 10V.

Between 1 and 10V, the fan speed is proportional to the command signal.

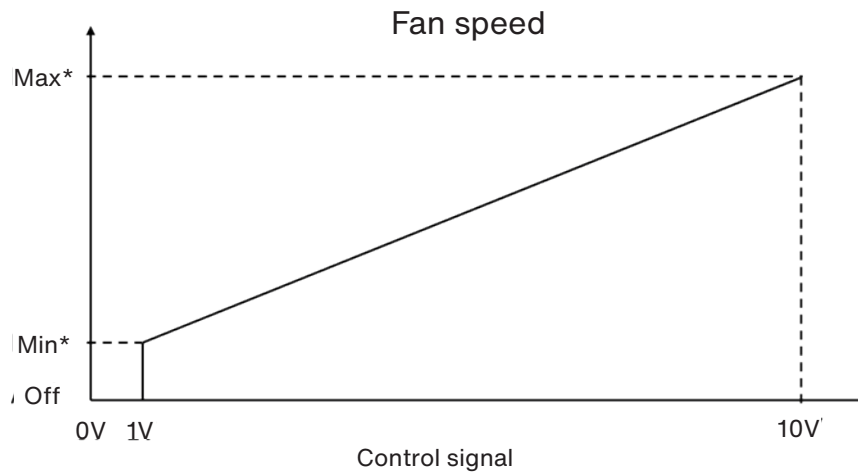

*The max and min speeds depend on the fan model.

The fan operation control is done either by:

- Pressure switch for ECO / DIVA versions factory set at 25 Pa.
- Pressure transducers for LOBBY versions (25Pa threshold set in the CLD-283 controller)
- Volume transducers (differential pressure + K factor) for MAC2 / QUATTRO versions (variable threshold set in the CLD-283 controller in accordance with the AHU model, see XV.11 Fan feedback and difference thresholds).

19.2. ECO controller

The ECO controller is an open loop control of the speed of the supply and exhaust air fans; there is no regulation. A speed setpoint (0-10V signal), which depends on the time schedule, is sent directly to the fan. The actual air volume or pressure at the supply or return is a result of the pressure/volume curve of the fan and the network curve.

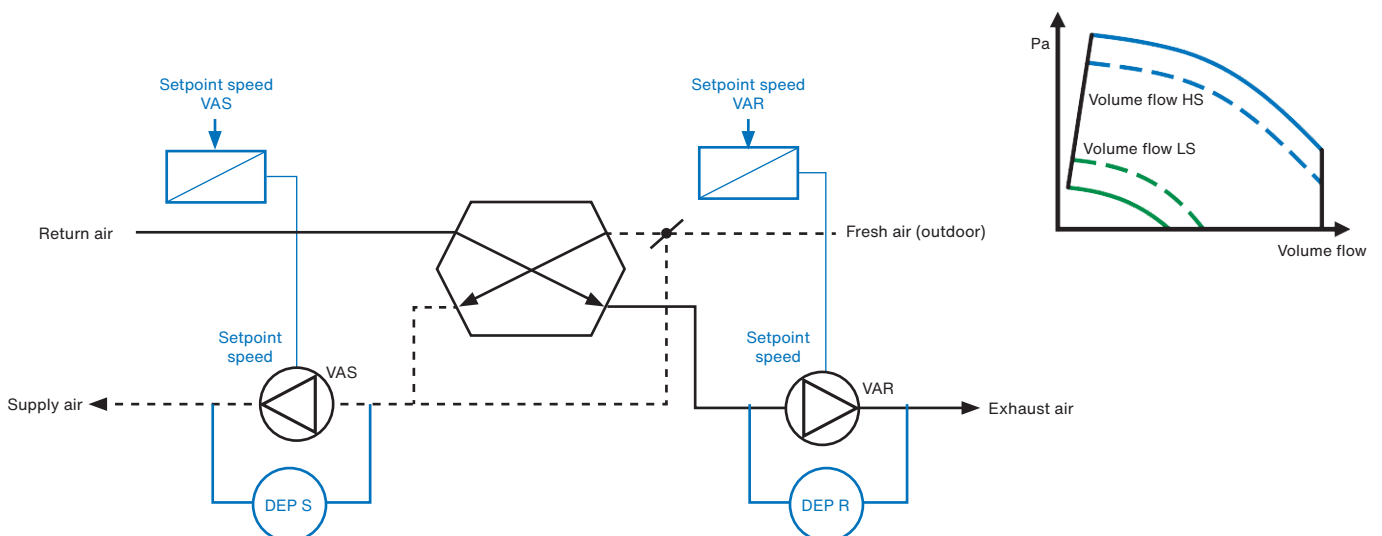

19.3. DIVA controller

The DIVA controller is a closed-loop control of the CO₂ on the return air by influencing the fan speed.

The speed of the supply and return air fans is adjusted individually and continuously according to an adjustable law from 3 CO₂/offset fan pairs in order to maintain a CO₂ concentration measured on the return air at an acceptable level for the comfort of the occupants while minimising the energy consumption from ventilation.

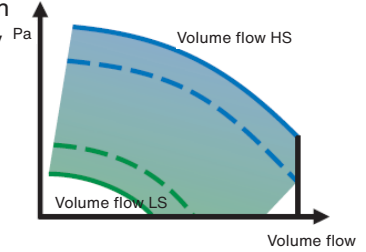
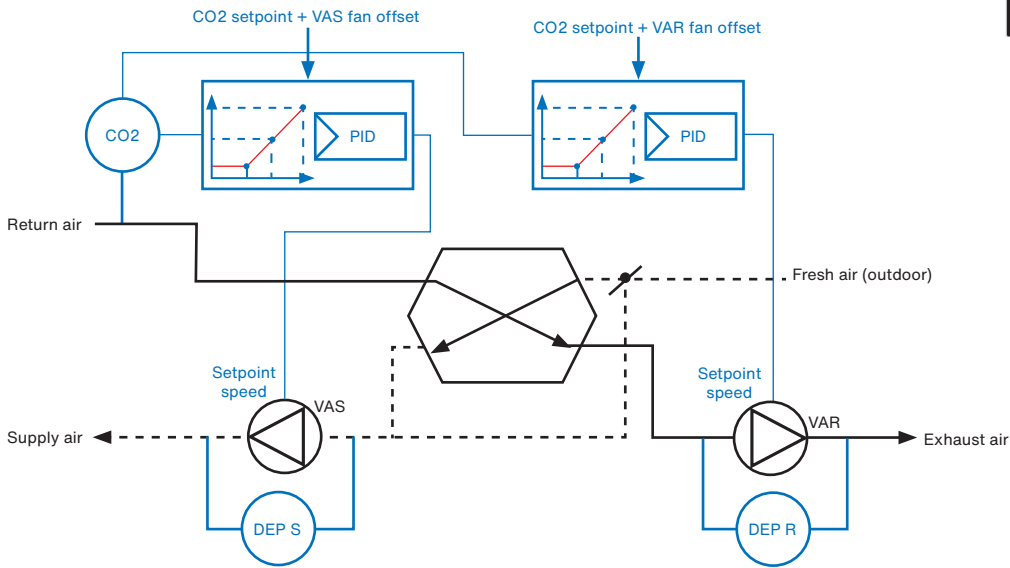

3 Offsets on HS and linear interpolation

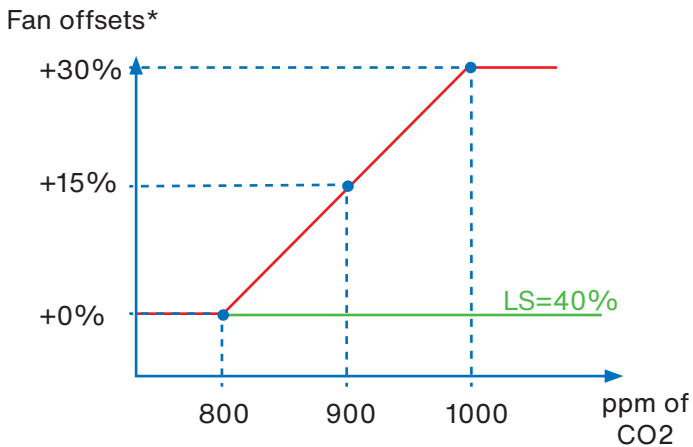

*Applied to the LS (low speed = reduced operation)

Below 800ppm, the fan offset is zero and the fan runs at 40% (factory setting) of its maximum speed. Above 1000ppm, the fan offset is kept constant at +30%, which gives a resulting speed of 70% of the maximum speed (40% + 30% = 70%). An intermediary point set at 900ppm and +15% offset makes it possible to make the behaviour of the fans more or less progressive or, conversely, to linearise it.

The factory settings are made to obtain a proportional variation of the fan speed over the range of 800 to 1000ppm of CO₂.

ppm CO ₂ (adjustable)	Fan offset (%) (adjustable)
800	0 (corresponding fan % = 40% = ECO reduced operation)
900	15 (corresponding fan % = 55%) $\frac{\text{Offset}_{1000} + \text{Offset}_{800}}{2}$
1000	30 (corresponding fan % = 70% = ECO reduced operation)

The 3 CO₂ and offset terminals can be changed by the user.

When setting the time schedule, it is important to set only one time slot for reduced operation as all the offsets apply to this operation. If a normal operating period is set, the CO₂ will not be effective and nor will the night cooling.

19.4. LOBBY controller

The LOBBY controller is a closed-loop control of the constant pressure type (or VAV = variable air volume).

The speed of the supply and return air fans is adjusted individually and continuously by means of a PID algorithm in order to obtain a measured actual pressure equivalent to the setpoint pressure adjusted in the controller regardless of the (variable) network conditions.

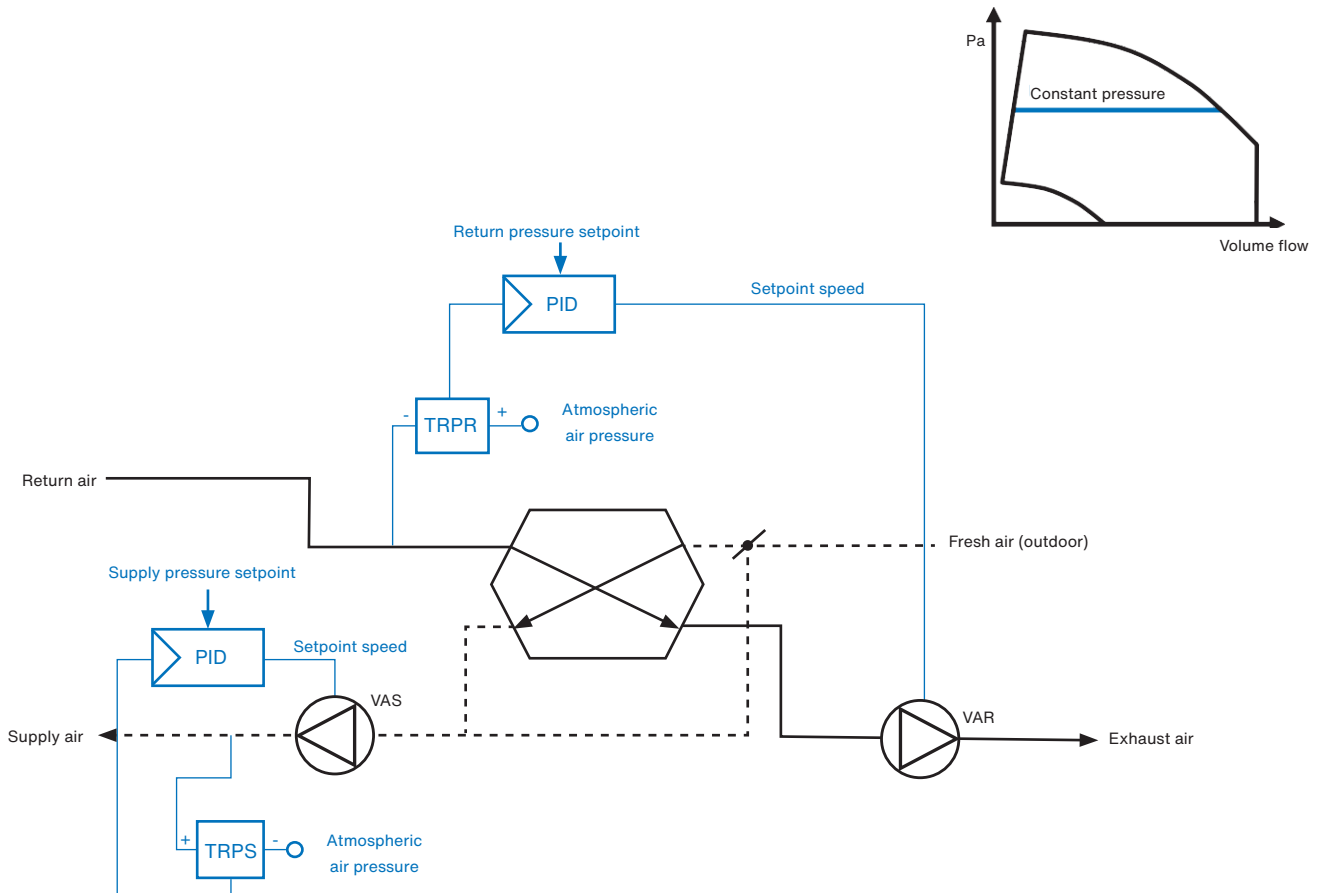

When the measured air pressure is lower than the setpoint, the controller increases the value (0-10V voltage) of the fan speed setpoint signal to increase the air volume and thus the resulting pressure, and vice versa.

It should be noted that as the network has a variable air volume, the thermal power delivered by any heating and/or cooling coils is variable, whether they are integrated into the ventilation unit or not.

A curved air duct placed directly at the inlet or outlet of the machine can interfere with pressure and operational instability. A distance of at least 5 times the diameter of the air duct must be maintained between the curved air duct and the machine.

The pressure settings for reduced and normal operation are identical ex factory as VAV air systems generally operate on a single pressure level. However, it is possible to set a normal operation pressure setpoint that is different (higher) than the reduced operation pressure setpoint, in order to potentially manage 2 different pressure levels or to further increase the resulting air volume when night cooling is activated. In the latter case, it must be ensured that the reduced operation remains active for the entire duration of the night cooling period (00:00 - 07:00).

19.5. MAC2 controller

The MAC2 controller is a closed-loop constant air volume (CAV) controller.

The speed of the supply and return air fans is adjusted individually and continuously by means of a PID algorithm in order to obtain a volume equivalent to the volume setpoint set in the controller, regardless of the extent to which the air filters are clogged.

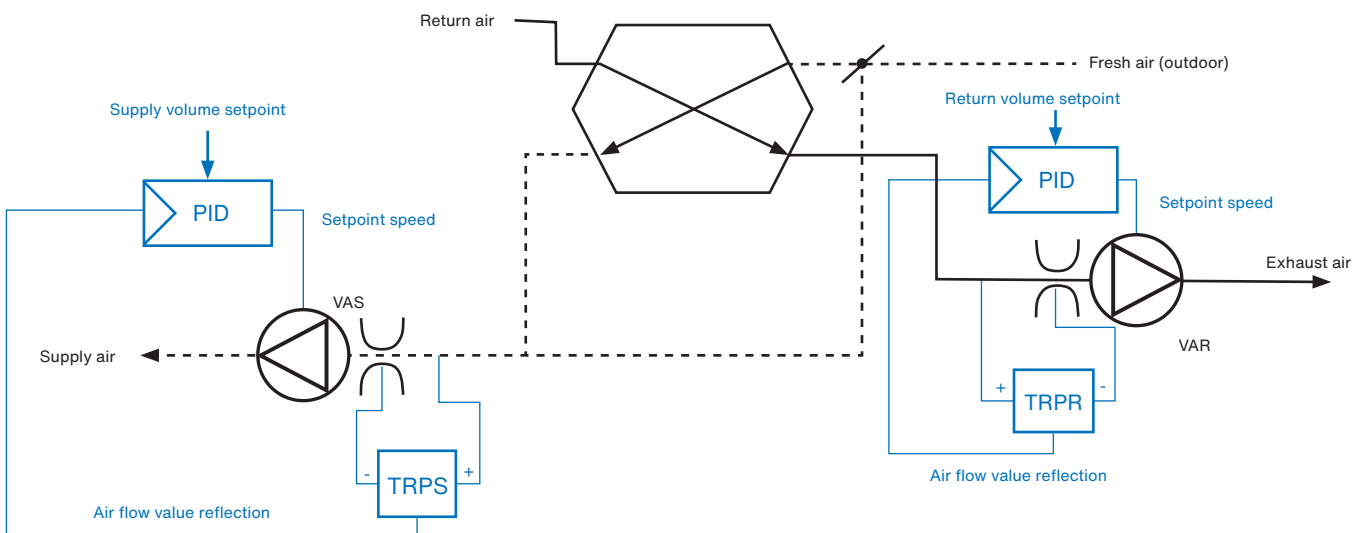
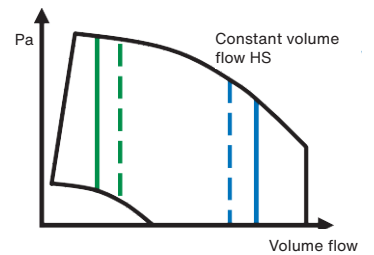

When the measured air volume is lower than the setpoint, the controller increases the value (0-10V voltage) of the fan speed setpoint signal to increase the resultant air volume, and vice versa.

19.6. QUATTRO controller

The QUATTRO controller is a closed-loop air volume controller based on the CO₂ concentration at the return.

The speed of the supply and return air fans is adjusted individually and continuously according to an adjustable law in order to maintain a CO₂ concentration measured on the return air at an acceptable level for the comfort of the occupants while minimising the energy consumption from ventilation.

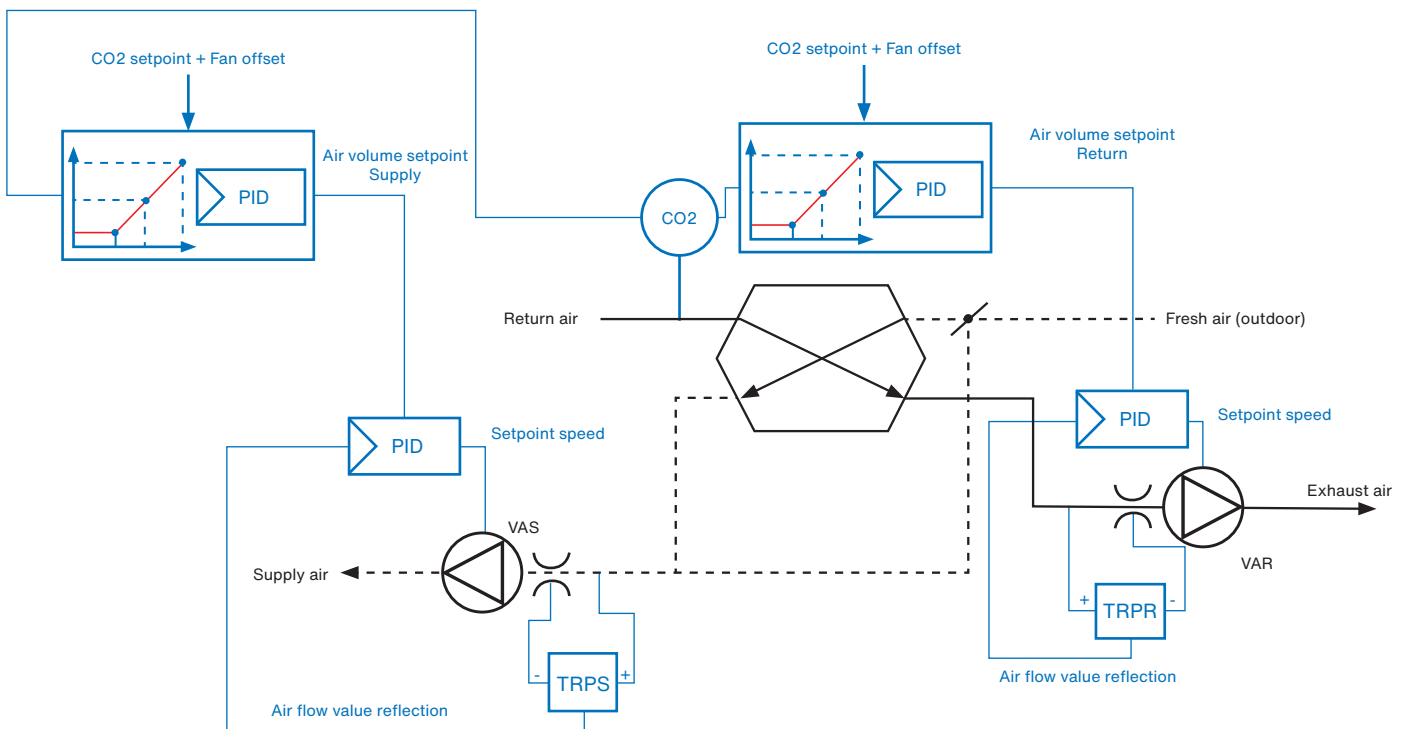
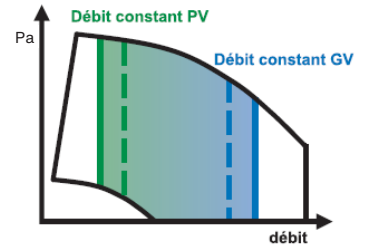

The difference compared to the DIVA controller is that here the fan speed setpoint is controlled in a closed loop to obtain an air volume setpoint. The QUATTRO controller allows greater precision because the air volume is known and therefore better controlled. It does not depend on the state of clogging of the filters and the minimum volume of the unit can be managed more precisely.



Factory settings are made to obtain a proportional variation of the fan speed or volume over the range 800 to 1000ppm CO₂ while remaining within a speed (DIVA) or volume (QUATTRO) modulation range equivalent to the respective ECO and MAC2 settings.

QUATTRO	
ppm CO ₂ (adjustable)	Fan offset (m ³ /h) (different for each machine model) (adjustable value)
800	0 (no offset = reduced volume flow in MAC2 version of the corresponding AHU model)
900	$\text{Offset}_{4000} + \text{Offset}_{800}$ 2
1000	Value that depends on the AHU model to obtain the volume of normal operation in MAC2 version of the corresponding AHU model) See XV.11 Fan feedback and difference thresholds

The 3 CO₂ and offset terminals can be changed by the user.

When setting the time schedule, it is important to set only one time slot for reduced operation as all the offsets apply to this operation. If a normal operating period is set, the CO₂ will not be effective and nor will the night cooling.

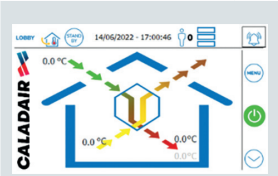
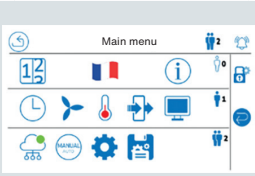
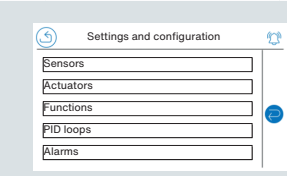
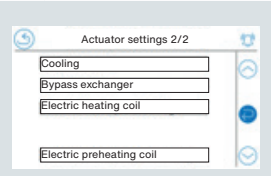
20. Control of the electric heating coil (BE)

Access path to the function (Access level: Expert)											
Step 1		→	Step 2		→	Step 3		→	Step 4		
From screen			→			→			→		
	Area to click						Actuators			Electric heating coil	

20.1. Modulation of thermal output

The electric heating coil is managed by the heating sequence and therefore has its own PID control loop which calculates a heating requirement from the supply (or return) temperature setpoint and the measured supply (or return) temperature. This requirement is converted into a PWM (Pulse Width Modulation) control signal used to drive the solid state power relays that provide power to the battery heating elements. The PWM signal period is 60 secs (not adjustable).

The PWM value is directly proportional to the calculated heating requirement. The PWM is translated directly to the DO output of the controller as follows:

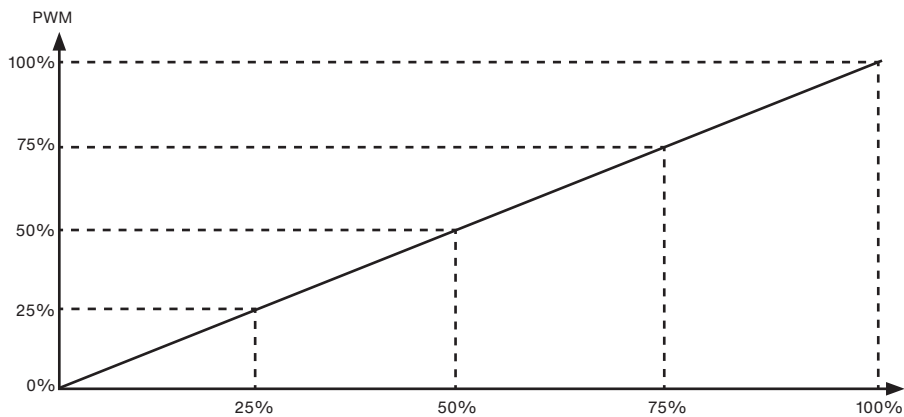

Heating requirement calculated by the PID according to the difference between the setpoint temperature and the temperature measured at the supply or return depending on the temperature control mode used

Status of the DO output for controlling the electric heating coil for different calculated PWM values

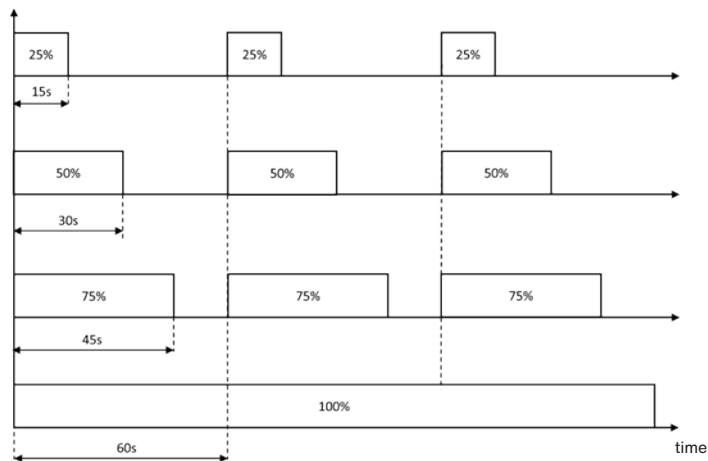

20.2. Overheating protection via safety thermostat THS

The supply air electric heating coil is controlled by the supply air fan feedback signal to prevent overheating of the heating element in case of a fan breakdown:

- If the supply air fan feedback is idle and there is a request to activate the heating resistor, it will not be activated
- If the electric heating resistor is activated and the supply air fan feedback drops, then the heating resistor will be deactivated.

This control does not exist for the electric fresh air preheating coil or in the case of a hot water heating coil.

The electric heating coil is equipped with an overheating safety thermostat set at +100°C, which protects the machine from accidental overheating (e.g. static relay failure). The overheating thermostat cuts off the power supply to the coil by opening the control circuit of contact transmitter K1, which activates the alarm (63) "Electric coil overheating" and stops the operation of the unit.

21. Control of the hot water heating coil (BC)

21.1. Modulation of thermal output

The hot water heating coil is managed by the heating sequence and therefore has its own PID control loop which calculates a heating requirement from the supply (or return) temperature setpoint and the measured supply (or return) temperature. This requirement is converted into a 0-10V control signal which is used as a position setpoint for controlling the modulating 3-way valve.

When the hot requirement is zero, the control signal is zero (0V). The hot water feed rate to the hot water heating coil is zero.

When the hot requirement is at its maximum, the control signal is at its maximum (10V) and the hot water feed rate to the coil is at its maximum.

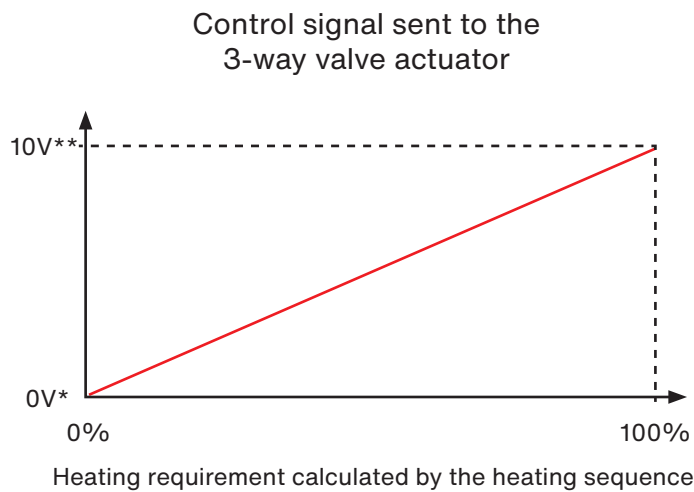

*0V: the 3-way valve is connected in such a way that the coil is not supplied with hot water

**10V: the 3-way valve is connected in such a way that the coil is supplied with hot water

21.3. Thermal output

To ensure thermal output, it is necessary to supply the heating coil with the required volume and temperature when selecting the material.

22. Control of the hot water pump

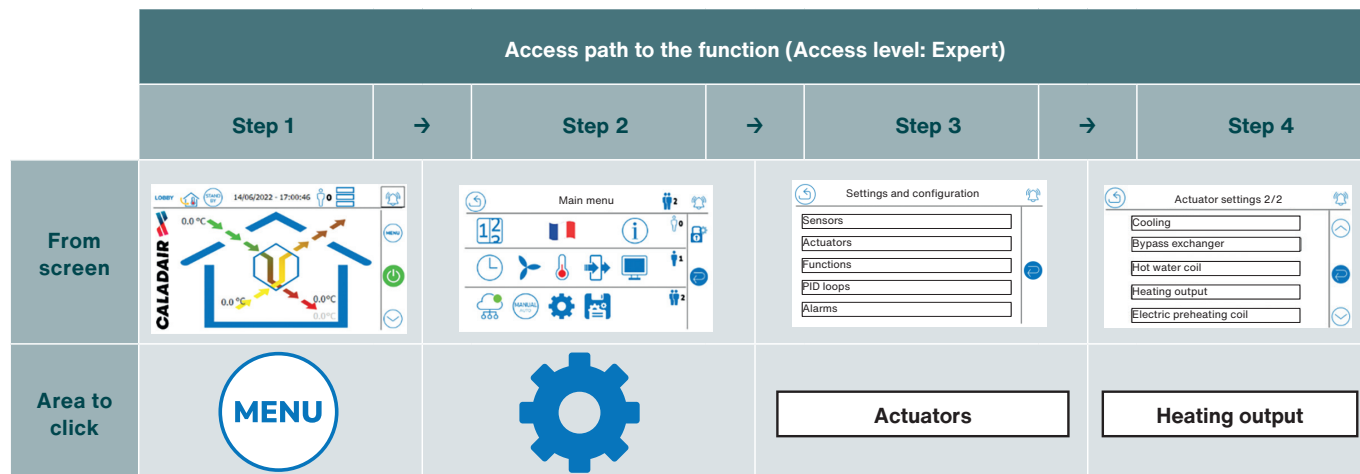

When the heating sequence is active (heating requirement > 0%) the DO output of the hot water pump control is activated.

When the requirement disappears (heating requirement = 0%), the DO output of the controller is deactivated.

This function is only available for controllers that support a hot water coil, it is not available for controllers that support an electric coil.

23. Control of the cold water coil

23.1. Modulation of thermal output

The cold water cooling coil is managed by the cooling sequence and therefore has its own PID control loop which calculates a cooling requirement from the supply (or return) temperature setpoint and the measured supply (or return) temperature. This requirement is converted into a 0-10V control signal which is used as a position setpoint for controlling the modulating 3-way valve.

When the cold requirement is zero, the control signal is zero (0V). The cold water feed rate to the cooling coil is zero. When the cold requirement is at its maximum, the control signal is at its maximum (10V) and the cold water feed rate to the coil is at its maximum.

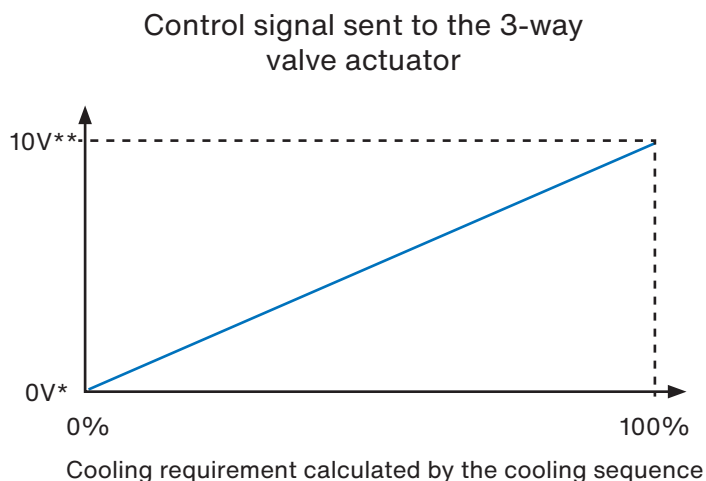

*0V: the 3-way valve is connected in such a way that the coil is not supplied with cold water

**10V: the 3-way valve is connected in such a way that the coil is supplied with cold water

23.2. Frost protection

The frost protection of the cold water coil must be ensured by a sufficient concentration of anti-freeze liquid (MEG or MPG) in accordance with the cold water generator and the temperature operating range of the cold water coil. If the use of a frost protection thermostat is considered, it must be external to the machine.

23.3. Thermal output

To ensure thermal output, it is necessary to supply the cooling coil with the required volume, temperature and concentration of anti-freeze (MEG or MPG) when selecting the material.

24. Control of the cold water pump

Access path to the function (Access level: Expert)							
	Step 1	→	Step 2	→	Step 3	→	Step 4
From screen							
Area to click							

When the cooling sequence is active (cooling requirement > 0%) the DO output of the cold water pump control is activated. When the requirement disappears (cooling requirement = 0%), the DO output of the controller is deactivated.

25. Control of the electric fresh air preheating coil

Access path to the function (Access level: Expert)							
	Step 1	→	Step 2	→	Step 3	→	Step 4
From screen							
Area to click							

The purpose of the electric fresh air preheating coil is to maintain a sufficient temperature (factory setting -5°C) at the fresh air inlet of the plate heat exchanger in order to avoid any risk of icing of the condensed water vapour on the return air side. It is optional equipment that complements the modulating bypass (standard equipment) and ensures protection against icing of the plate heat exchanger, particularly in cold climatic zones, and allows the machine's operating range to be extended.

It operates in an on/off mode based on an algorithm that compares the actual value of the fresh air inlet temperature in the plate heat exchanger with the setpoint. The electric fresh air preheating coil therefore only comes into operation when the outside air temperature is below -5°C .

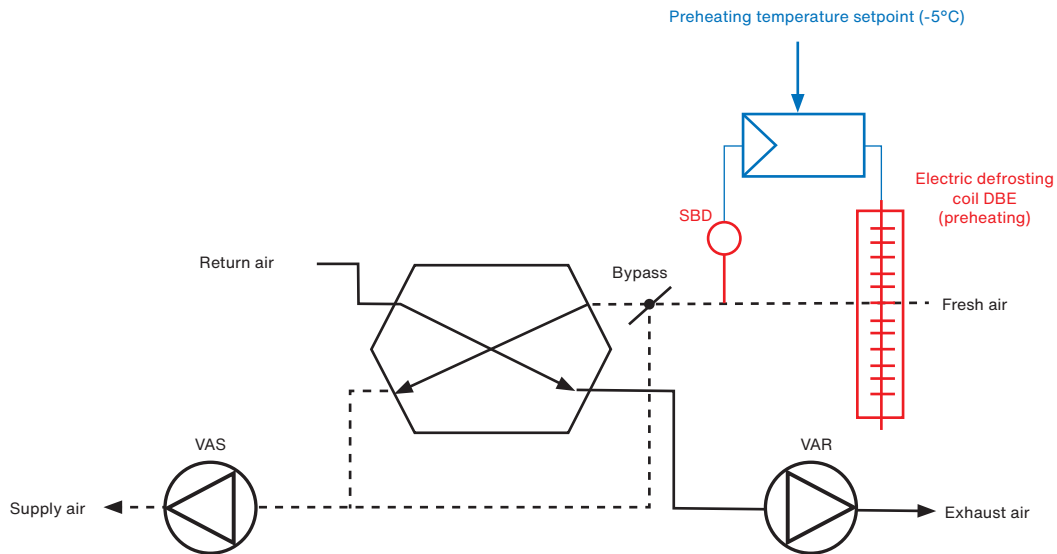

The sequence is managed by a PID. The DO output that powers the resistor is of the on-off type (all or nothing).

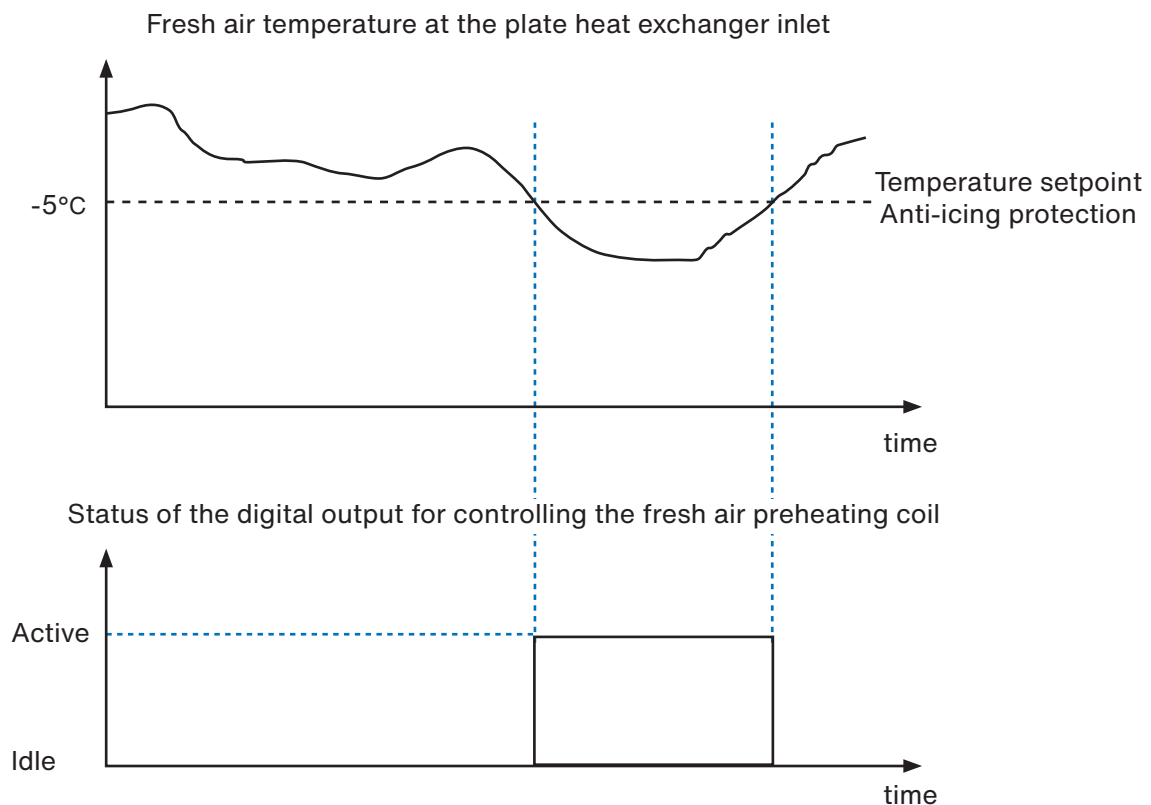

This sequence is independent of the heating, recovery, cooling and anti-icing bypass sequences. The electric fresh air preheating coil is equipped with an NC (normally closed) safety thermostat (THSD) set at $+100^{\circ}\text{C}$, which cuts off the power supply to the KD contact transmitter control circuit when activated to protect the machine from overheating.

26. Control of the rotary heat exchanger

26.1. General

The rotary heat exchanger consists of a wheel (exchanger) driven by a stepper motor via a belt.

Unlike the plate heat exchanger, the rotary heat exchanger does not have a bypass function, either to manage the recovery rate or to manage the anti-icing protection. The control of the rotary heat exchanger is done only by adapting the speed of the wheel. At zero speed, there is no recovery. At maximum speed, there is maximum recovery. The recovery performance is not quite proportional to the speed of rotation.

26.2. Modulation of the heat recovery rate

The rotary heat exchanger is managed by the heat recovery sequence and therefore has its own PID control loop which calculates an energy recovery requirement from the supply air temperature setpoint and the measured supply air temperature. This requirement is converted into a 0-10V control signal which is used as a setpoint for the wheel speed.

The wheel drive motor starts when the signal exceeds 1.1V and stops when the signal drops below 0.6V. Above 9.5V, the exchanger operates at maximum speed. Between 1.1V and 9.5V, the rotation speed of the wheel follows the law of the graph below.

The speed variation ramp is set to 60s (it takes 60s to go from minimum to maximum speed).

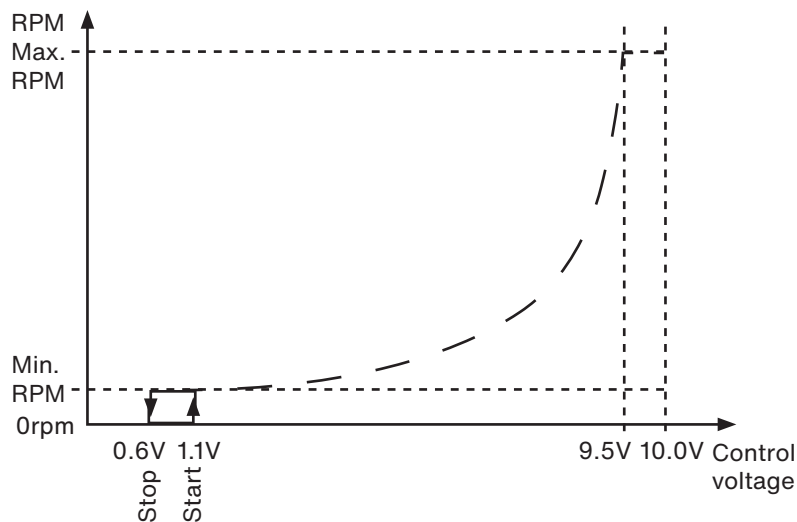

26.3. Rotary heat exchanger feedback

The electronic wheel management unit has a control function that informs the controller whether the wheel is turning correctly or not. If a wheel rotation fault is detected, an alarm is recorded and displayed on the PG 5.0 touchscreen.

The control of the wheel rotation is based on the correlation between the expected current, voltage, EMF and the actual conditions (rotation speed, temperature, etc.) of the motor.

In this way it is possible to determine, for example, whether the belt is broken (zero resistive torque), whether the rotor is blocked (high resistive torque), or whether the motor is defective without an external sensor.

Therefore, the device does not use an external inductive or Hall effect sensor.

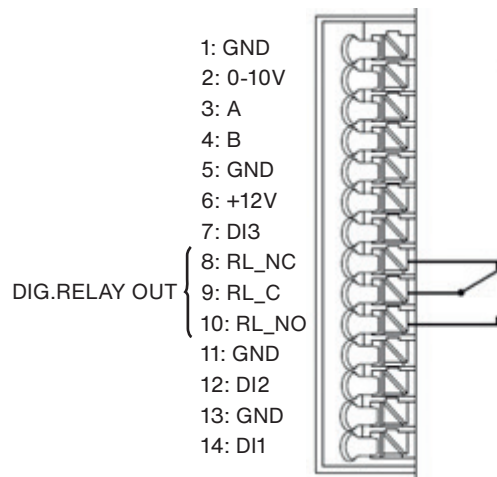

The feedback from the heat exchanger uses the normally open NO output DIG RELAY OUT (wired between (9) and (10)). When there is a fault, the contact remains open and closes if the wheel is working properly.

27. Control of the plate heat exchanger

27.1. General

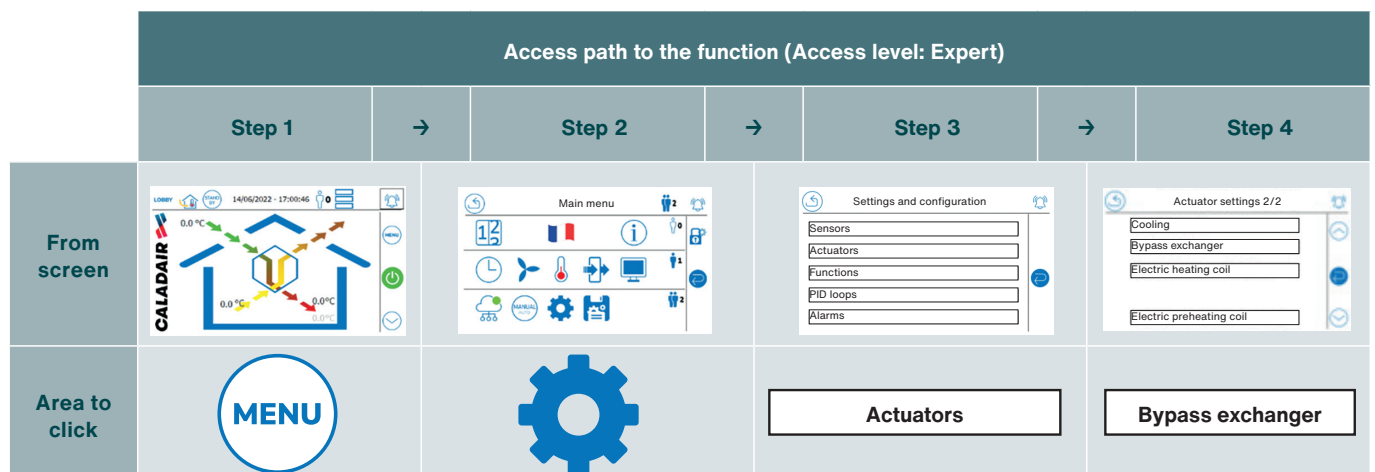

The performance of the plate heat exchanger is continuously adjusted through the use of a bypass flap placed on the fresh air stream.

When the need for heat recovery is greatest, the bypass is closed and forces the entire fresh air volume through the exchanger to transfer/recover energy to the return air. Conversely, when there is no need for heat recovery (free cooling or, more rarely, free heating), the bypass is opened, thus diverting the fresh air volume from the exchanger.

The bypass operates when there is:

- A need to modulate heat recovery, which is the case when:
 - There is a heating requirement and the return air temperature is higher than the fresh air temperature (the fresh air is possibly preheated to -5°C)
 - There is a cooling requirement and the extraction temperature is lower than the fresh air temperature
- A risk of the heat exchanger icing up. In this case, the heat recovery modulation is no longer active and the anti-icing protection takes priority.

27.2. Modulation of the heat recovery rate

The bypass is managed by the heat recovery sequence and therefore has its own PID control loop which calculates an energy recovery requirement from the supply air temperature setpoint and the measured supply air temperature. This requirement is converted into a 0-10V control signal which is used as a setpoint for the bypass flap position. The actuator starts to open at 2V and is fully open at 10V. Between 2V and 10V, its position is proportional to the voltage. Below 2V, the bypass is open. The opening/closing time of the flap is variable depending on the actuators used: from 35 secs to 150 secs.

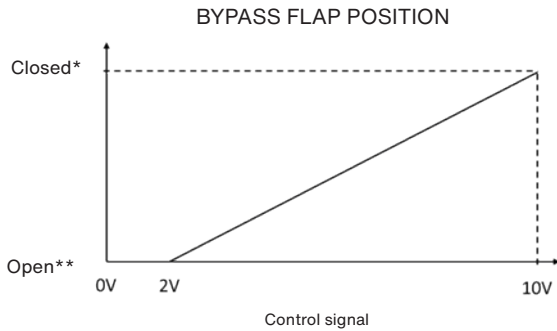

≤2V = bypass is 100% open (no heat recovery or anti-icing protection is active)
 10V = bypass is closed (maximum heat recovery or anti-icing protection is idle).

*Closed: all the fresh air volume passes through the exchanger (maximum heat recovery)
 **Open: all volume is diverted from the exchanger (no heat recovery)

27.3. Protection against icing of the plate heat exchanger

Access path to the function (Access level: Expert)							
	Step 1	→	Step 2	→	Step 3	→	Step 4
From screen							
Area to click							

When the anti-icing function is active, it can be identified by the pictogram in the “operating mode” area of home page 1.

In order to prevent the icing up of the exchanger on the return air side when the outside air temperature is particularly low (winter period, installation at altitude, etc.), the cold fresh air volume is diverted from the exchanger in order to prevent the exhaust air from reaching the icing temperature, which could obstruct the return air volume. The bypass thus enables this function. When the bypass temperature (return air temperature) falls below the specified temperature setpoint (+3°C), the bypass is controlled to protect the exchanger against icing and no longer regulates according to the energy recovery requirement.

The anti-icing protection is a specific and independent sequence with its own PID control parameters.

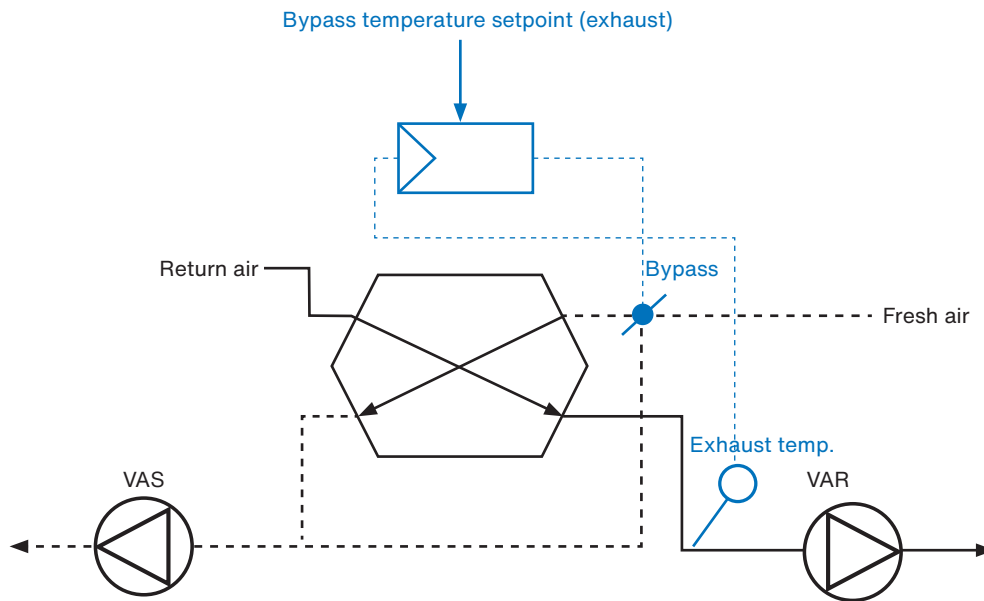

When the anti-icing function is activated, the modulating bypass control is managed by specific PID parameters that are different from the PID parameters that manage the recovery rate. This allows the dynamics of the actuator to be adapted for this more constrained operating phase (need for greater responsiveness) in order to maintain the exchanger's air temperature $\geq +3^{\circ}\text{C}$.

- The anti-icing sequence is independent of the heating, recovery, cooling and fresh air preheating sequences. It is also used as a condition for activating the supply air volume reduction function (see

ANTI-ICING FUNCTION BY REDUCING THE SUPPLY AIR VOLUME).

The anti-icing function is activated when the exhaust temperature drops below $+3^{\circ}\text{C}$ and stops when the temperature rises above $+4^{\circ}\text{C}$. The anti-icing PID sets are used the whole time the function is active. This function has priority over the heat recovery function and remains active for a minimum of 5 minutes from when it is activated, regardless of the measured exhaust temperature.

Status of the analogue output for bypass actuator control

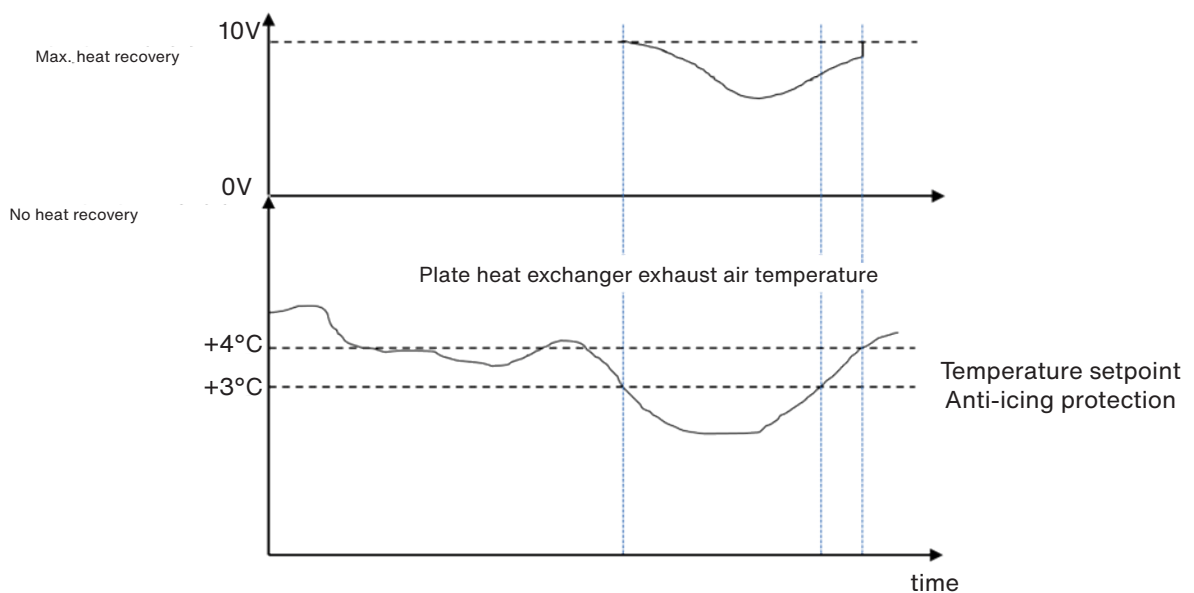

28. LOBBY pressure transducers

The LOBBY pressure transducer is a differential pressure transducer.

It converts the pressure difference between the atmospheric pressure and the pressure in the associated air stream (supply or return) into an analogue signal that can be evaluated by the controller. Its output signal is 0-10V and directly proportional to the measured differential pressure.

TRPS/TRPR pressure transducer
LOBBY

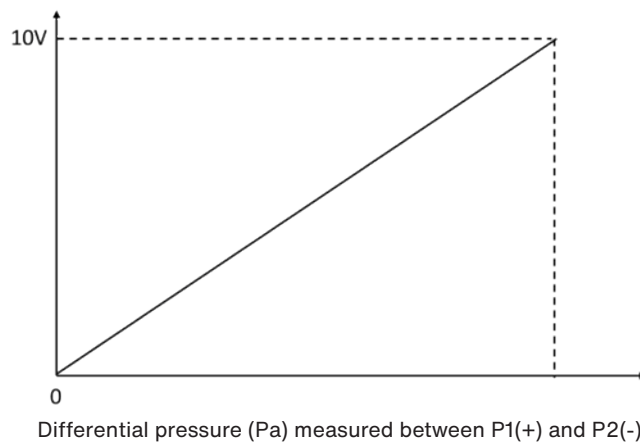

For the LOBBY machine versions, the air pressure is also used as a feedback signal for the fans. When the measured pressure is below a certain threshold (25 Pa factory setting for all machines), the controller interprets this as a fan malfunction and may activate certain alarms. If an electric heating coil is used, it is only activated if the pressure is higher than the return pressure threshold of the supply air fan. This is an activation condition. The LOBBY pressure transducer is identical for all machines.

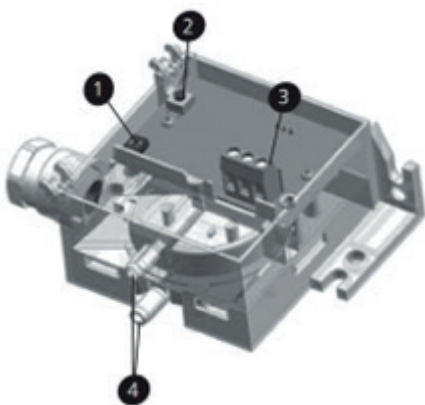

Reference point	Details
1	Setting jumpers
2	Zero setting (sensor must be in its operating position, pressure taps disconnected and fans off)
3	Electrical connection terminal block
4	Pressure taps P1(+) et P2(-)



Max. differential pressure rating = 1600 Pa
The jumpers are in the OFF position (position 0)

29. MAC2 / QUATTRO pressure transducers

The MAC2 pressure transducer is a differential pressure transducer.

It converts the pressure difference measured at the terminals of the fan's Venturi system (suction fan chamber) into an analogue 0-10V signal that can be processed by the controller.

The output signal is 0-10V and directly proportional to the measured differential pressure.

TRPS/TRPR pressure transducer MAC2- QUATTRO

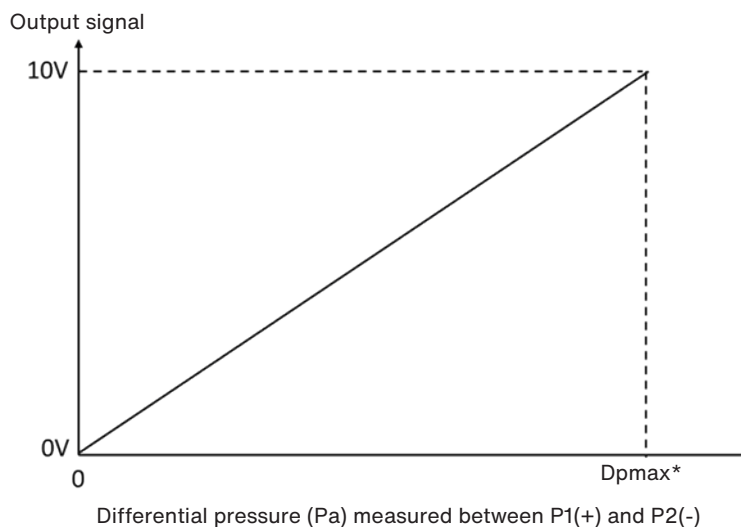

*DPmax depends on the model of the ventilation unit (300Pa/1600Pa/5000Pa)

From the known characteristics of the inlet ring it is possible to convert the measured pressure difference into volume flow with the following equation:

$$Q = K \times \sqrt{\Delta P}$$

Q	Volume flow
K	Coefficient
ΔP	Pressure difference

The K-factor is factory-set in the control programme for each machine.

The supply and return air volume is also used as a fan run feedback signal. When the measured volume is below a certain threshold (different for each machine), the controller interprets this as a fan malfunction and may activate certain alarms. If an electric heating coil is used, it is only activated if the volume is higher than the return volume threshold.

The size of the MAC2 / QUATTRO pressure transducers depends on the type of machine.

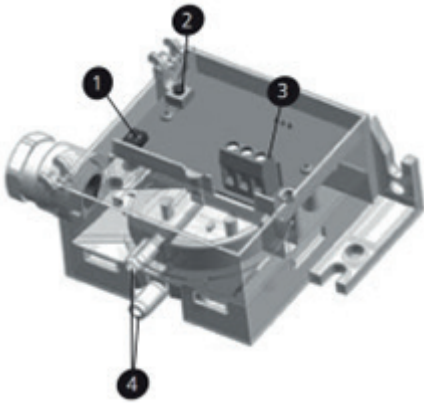

Reference point	Details
1	Setting jumpers
2	Zero setting (sensor must be in its operating position, pressure taps disconnected and fans off)
3	Electrical connection terminal block
4	Pressure taps P1(+) et P2(-)

Setting the jumper position:

ON

1		
0		
1	2	

Max. differential pressure rating
(300 Pa / 1600 Pa / 5000 Pa depending on version)
The jumpers are in the OFF position (position 0)

30. ECO / DIVA fan operating control pressure switches

The ECO and DIVA unit versions are equipped with an adjustable pressure switch (factory set at 25 Pa) to control the operation of the supply and return air fans by measuring the differential pressure.



The pressure switches are of the NO type (normally open), electrical connection between terminals (1) and (3). The contact is open in the idle state when there is no air volume and closes when fan air volume results in a differential pressure of more than 25 Pa.

DEP S – DEP R pressure switch
ECO - DIVA

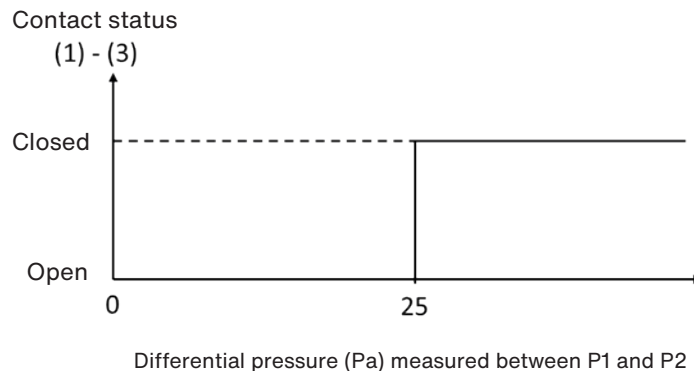

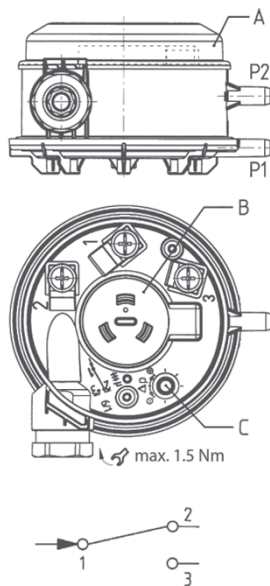

Reference point	Details
P1 (+)	Positive pressure tap
P2 (-)	Negative pressure tap
A	Removable lid
B	Setting
1	Common terminal
2	NC contact terminal (not used)
3	NO contact terminal

Control method:

First of all, check the connection of the pressure tap tubes (crystal tubes) and that there is no moisture or foreign bodies (insects, grease, etc.) inside them.

Machine (fan) off:

- Contact between terminals (1) and (3) is open (∞ Ohms) Pressure switch electrically disconnected
- The voltage between terminals (1) and (3) is a 24V DC electrically connected pressure switch
- The corresponding digital input (DI) must indicate an "idle" state

Switch the fan to manual operation and request a setpoint of 50%:

- Contact between terminals (1) and (3) is closed (< 2) Pressure switch electrically disconnected
- The voltage between terminals (1) and (3) is a 0V DC electrically connected pressure switch
- The corresponding digital input (DI) must indicate an "active" state.

31. PT1000 temperature sensor

The PT1000 temperature sensors are sensors whose sensitive element is made of platinum (PT), which is very robust, very accurate and has almost no deviation over the entire service life of the unit. It is therefore not necessary to replace them during preventive maintenance.



The resistance of the sensor is 1000 Ohms at 0°C. The resistance versus temperature characteristic of the sensor is shown below:

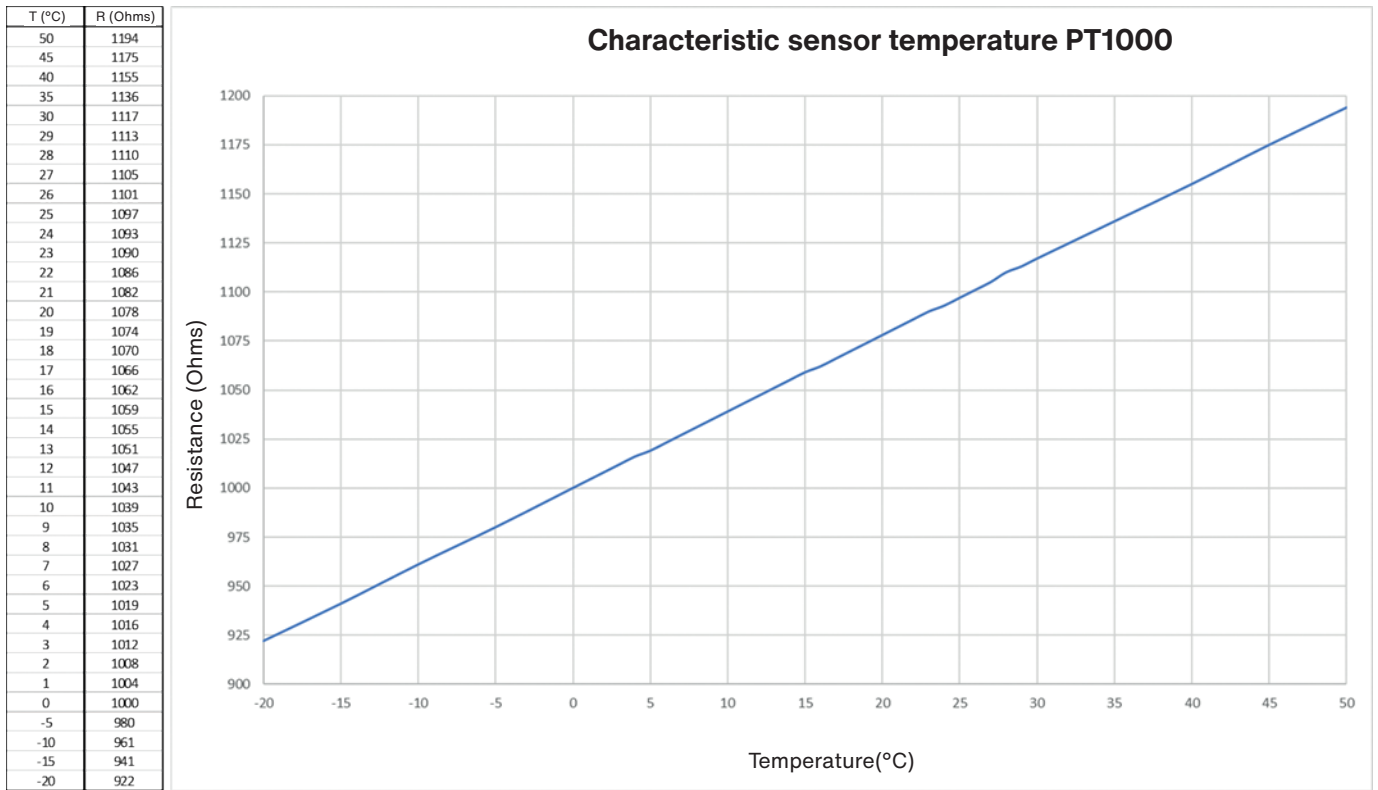

The control of the sensor is done with an ohmmeter and a second reference temperature sensor and must integrate the whole measuring loop: sensor + wiring + plug, as close as possible to the corresponding controller input.

32. CO₂ sensor

The CO₂ sensor converts the CO₂ concentration in the air stream in which it is installed (return) into an analogue signal (0-10V) that can be evaluated by the controller.

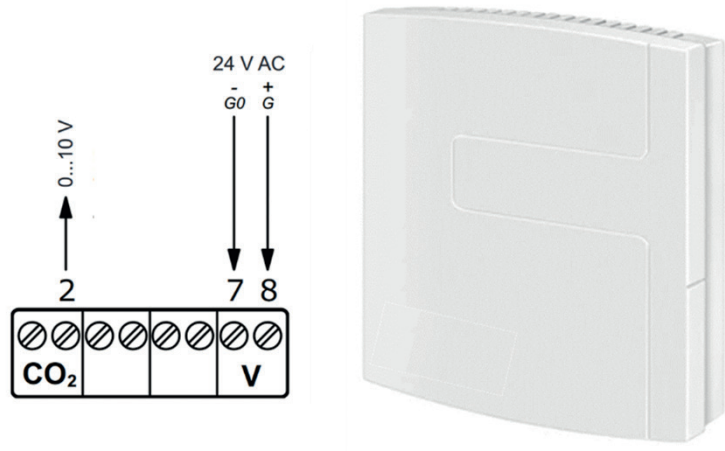

The output value of the sensor depends directly and proportionally on the CO₂ concentration in the air:

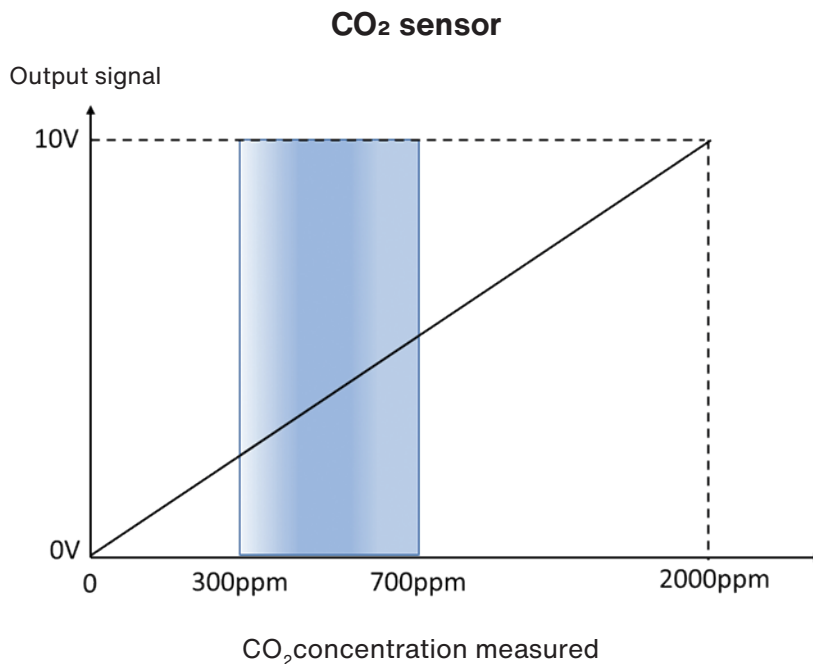

The CO₂ sensor may be sensitive to dust and deposits. The preventive maintenance of the filters on the return air will allow the correct functioning of the sensor to be maintained over time and limit the deviation of the measurement.

The ambient air outside contains about 300 to 600ppm of CO₂ depending on the location. In the city and in dense and polluted areas, the concentration can reach 600 or even 700ppm depending on the time of day. In low-density areas, the concentration is about 400ppm. This information can be used to determine whether the sensor is malfunctioning: if the output signal is measured at 0V (i.e. 0ppm), or if an output signal of 7.5V corresponding to 1500ppm is measured in the ambient air in an extra-urban area, the sensor may be malfunctioning and should be replaced. It is not possible to calibrate the sensor.

33. Help with setting PID parameters

A PID (Proportional Integral Derivative) control loop is a digital algorithm integrated in the controller that continuously calculates a setpoint (e.g. fan speed setpoint) from the difference (error) between the adjusted setpoint (e.g. supply air pressure) and the measured actual value (measured supply air pressure). It is a closed-loop controller.

The purpose of this algorithm is to continuously adjust the output value to cancel out the difference between the setpoint and the measured value at any operating point of the machine, just as someone would do when operating control buttons.

As the machine is factory set with a "general" set of PID parameters to suit most installations, it is possible that in some cases the PIDs may need to be adjusted during commissioning or after some time in operation. Generally, the problems to be corrected are:

- Pumping: e.g. the supply air fan is pumping and causes large variations in air volume, which leads to acoustic problems for the building's occupants
- It takes too long to reach the setpoint or there is still too great a difference between the setpoint and the measurement.

It is usually necessary to modify P and/or I when the setpoints configured (fan, temperature, etc.) deviate significantly from the factory setpoints, and/or when the installation (network volume/length, size/volume of the building, etc.) has an unconventional design, as well as if the machine is under/oversized with an operating point that is far from the nominal operating point. For example, it is possible to:

- Increase P supply air fan in LOBBY if the supply pressure setpoint is significantly increased
- Increase the I supply air fan in LOBBY if the supply network is very short and uneven.
- Oversizing: increase P and I
- Undersizing: decrease P and I

Factory settings of the PID parameters of the LOBBY version fans			
	P	I	D
Supply air fan VAS	500 Pa	20 seconds	There is no derivative
Return air fan VAR	500 Pa	20 seconds	

The first prerequisite before changing the settings of a PID is to check whether the measurement of the variable to be controlled (e.g. supply pressure in LOBBY) is stable. If it is unstable, the cause must be determined and rectified. Typical causes include:

- The sensor (temperature, pressure, volume flow, etc.) is incorrectly installed and is subject to interferences (turbulence, radiation, leaks, etc.). In this case, one should try to move the sensor to a more remote place or to calm the conditions by installing specific devices
- Presence of an external disturbance that generates air volume instabilities in the machine (e.g. 90° curved air duct immediately after leaving/entering the unit, gusts of wind, etc.).
- External disturbance such as dampers or vents opening/closing too quickly - change the opening and closing speeds of the dampers and leave a minimum opening.

	Definition	Details	Example of a general equation	Influence
P	Proportional strip	It is the gain reflection; the output signal is directly proportional to the difference between the setpoint and the measurement	$1/P \times (\text{Setpoint} - \text{measurement})$	<p>↑ P = the output signal decreases for the same error</p> <p>↓ P = the output signal increases for the same error</p> <p>If P is too low, the system becomes unstable. If P is too high, the system is slow.</p>
I	Integral	Cancels the static error (error that the P term cannot cancel) when the operating conditions are stable.	$1/I \times \int_0^t (\text{Setpoint} - \text{measurement}) dt$	<p>↑ I = the output signal decreases for the same error</p> <p>↓ I = the output signal increases for the same error</p>
D	Derivative	Pre-emptive term, not generally used in ventilation and air handling because it causes instabilities in “slow” systems	The derivative is not used.	

The output values of the P and I terms are totalled and converted to a global output value (e.g. fan speed signal).

Actual response of the system	Corrections to be made	
	P	I
<p>Fluctuations around the setpoint</p>	↑	
<p>Exceedance</p>	↑	↑
<p>Instability</p>	Check the stability of the measurement and the absence of external disturbances (turbulence, etc.) Check the sizing of the machine against the actual operating conditions, and/or the compatibility of the setpoint with the system.	
<p>Response too slow</p>		↑

*The measurement is stable and is not disturbed by conditions outside the unit

34. Control of the output voltage of the digital outputs DO

All digital outputs DO1 to DO7 are polarised at the same voltage as the supply voltage of the controller, i.e. 24V AC (~28-29V AC actually). They are also all equipped with MOSFET (Metal Oxide Semiconductor Field Effect Transistor) technology.

Unlike a conventional transistor, the distinctive feature of this type of transistor is that it delivers a voltage close to its supply voltage when it is at a standstill and without load (idle). When a load is connected, the output voltage drops to 0V AC.

It is therefore possible to measure the presence of a voltage at the output of the controller when the DO is in the idle state, which is misleading but quite normal. This difference in operation is very important when conducting a diagnosis on DOs or on a consumer connected to them.

The table below summarises the values to be obtained for a controller supply voltage of approximately 28V AC:

DO status (NO)	Load	Measured voltage between GDO and DO...
Idle (open)	Absent (open circuit or plug disconnected)	Approx. 20-25V AC (If 0V AC, may indicate a faulty controller)
	Present (>10mA)	0V AC (If ~24V AC, may indicate a faulty controller)
Active (closed)	Absent (open circuit or plug disconnected)	28V AC (supply voltage of the controller) (If 0V AC, may indicate a faulty controller)
	Present (>10mA)	

35. Presentation of the “PG 5.0” touchscreen

35.1. Technical specifications

Display technology	LCD TFT (Liquid Cristal Display – Thin-Film Transistor)
Touchscreen technology	Resistive
Number of colours	65K
Diagonal of the active area	4.3”
Display resolution	480 pixels x 272 pixels
Adjustable brightness	Yes
Adjustable standby mode	Yes
Display languages	French, English, Spanish, Italian, German
Protection class	IP65
Electrical insulation class	III
Maximum power consumption	7W

35.2. Software version and regulatory compliance

The PG 5.0 touchscreen and the controller communicate with each other via an RS485 serial bus. The display reads and writes data to the controller. It is important that the software compatibility between the controller and the display is ensured in order for the hardware to function properly.

The software versions of the display and controller can be accessed on the “Programme info” page from the symbol on the “Menu” page.

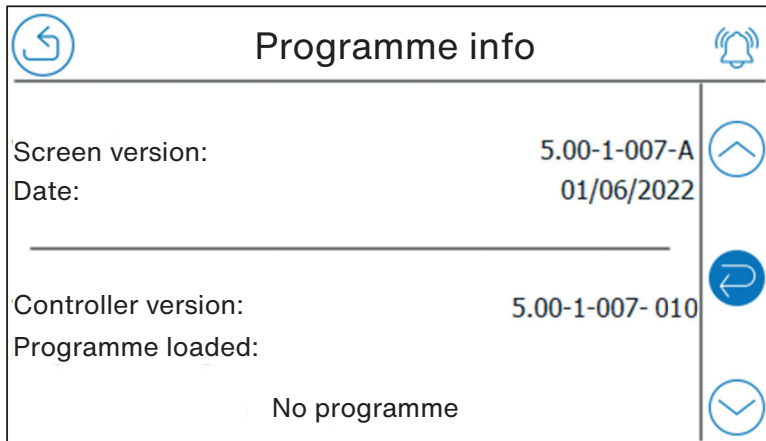

35.3. PG 5.0 touchscreen basic settings

The basic settings can be accessed by any user, no password is required. Thus, anyone can change:

- The display language
- The screen brightness
- The standby mode timer

35.4. Access level

Access to the various functions of the Zehnder Easy 5.0 controller is password-protected, which allows the level of access and operational security of the machine to be managed.

The password is an unchangeable 4-digit character stored permanently in the controller's memory.

Access level	Password	Function
Guest	None	The Guest access level gives access: <ul style="list-style-type: none"> ▪ To language, screen brightness, standby mode timer settings ▪ To reading only the main status information and values of the machine ▪ To resetting or adjusting the maintenance counter interval ▪ To active alarms and the history of recorded alarms
Service	3333	All Guest level functions as well as: <ul style="list-style-type: none"> ▪ Setting the clock and time schedules ▪ Setting the ventilation parameters ▪ Setting the thermal parameters ▪ Reading the controller's input/output values ▪ Setting the Zehnder EDT2 remote room control
Expert	1111	All Service level functions as well as: <ul style="list-style-type: none"> ▪ Setting the communication protocol ▪ Access to the manual control function ▪ Setting and activation of specific functions ▪ Backup and restoration of user/factory settings

35.5. Dashboard and home pages

35.5.1. Home page 1

The home page is permanently displayed when the standby screen is not active.

It is a dashboard that allows you to see the general operating status of the machine at a glance:

- The current time and date
- The current temperature operating point and temperature setpoint (supply or return)
- Fan controller type (ECO, LOBBY, DIVA, MAC2, DIVA, QUATTRO)
- Type of temperature controller (constant supply, supply based on air law, constant return, return based on air law)
- Current operating mode
- Current access level
- Current thermal requirements for cooling, heat recovery and heating
- The presence of an operation override by the BMS (BMS Override)
- The presence and total number of active alarm(s)

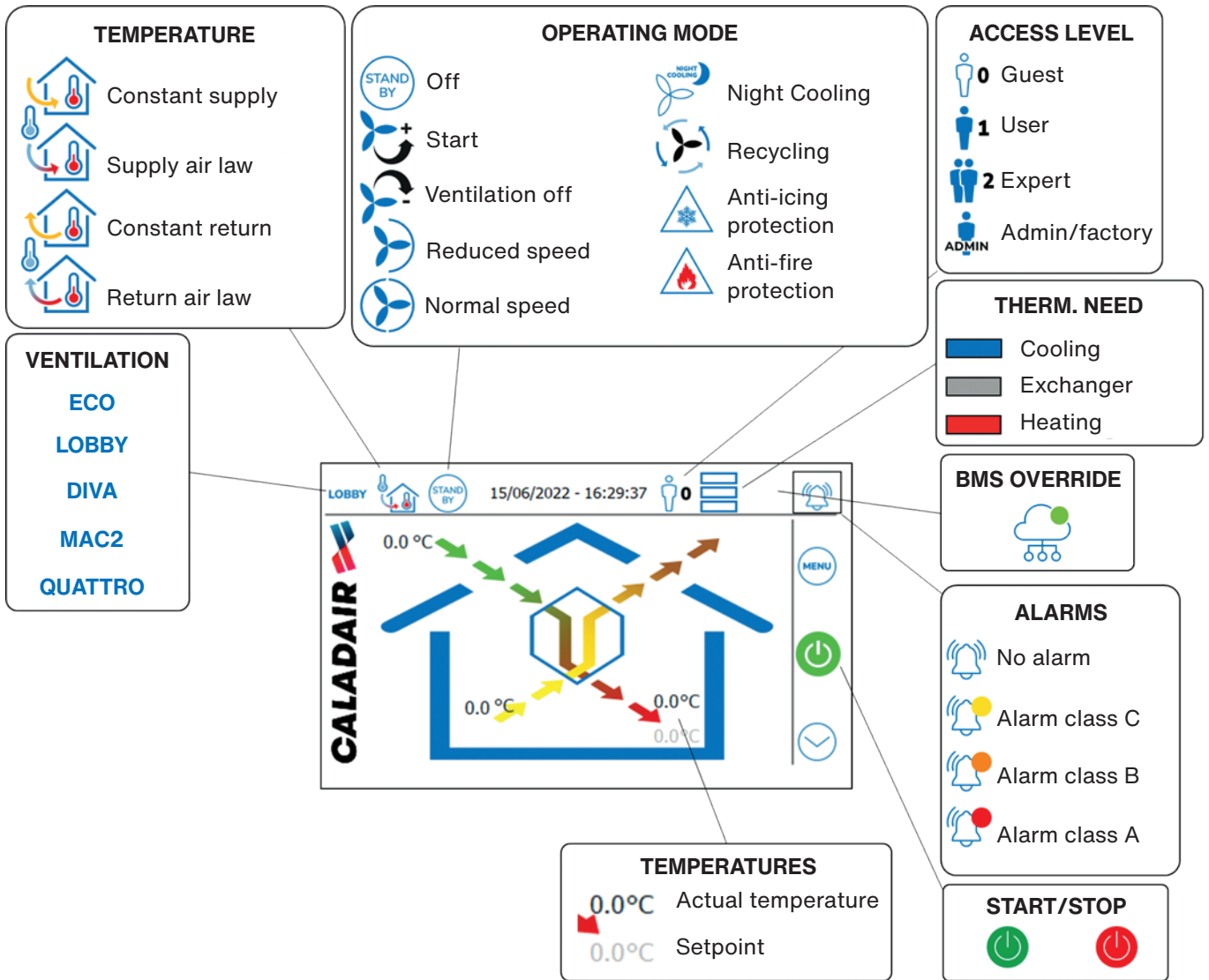

35.5. 2 Home page 2

Home page 2 can be accessed from home page 1 (button) by any user and complements the information on home page 1. In particular, it shows the current temperature and ventilation setpoints as well as the actual values measured. This makes it possible for anyone without access rights to check the consistency between the individual measured values as well as between the setpoint values and the measured values in case a simple and quick diagnosis is required.

CALADAIR		LOBBY	STAND BY	15/06/2022 - 16:29:37	0		
Supply	Current setpoint	Measure					
	Fan:	0	0 Pa				
	Temperature:	0.0	0.0 °C				
	Return	Current setpoint	Measure				
		Fan:	0	0 Pa			
		Temperature:		0.0 °C			
		Fresh air temperature:		0.0 °C			
Bypass temperature:		0.0 °C					
Preheating temperature:		0.0 °C					

35.5.3. Home page 3

Home page 3 can be accessed by any user from home page 2 (button) and complements the information on home pages 1 and 2 by indicating the current modes and sequences and the presence of a possible external request from either the CTM or the external stop DI input. An active BMS request may, for example, be the cause of uncontrolled machine operation. An active external stop request may be the result of a machine being permanently stopped.



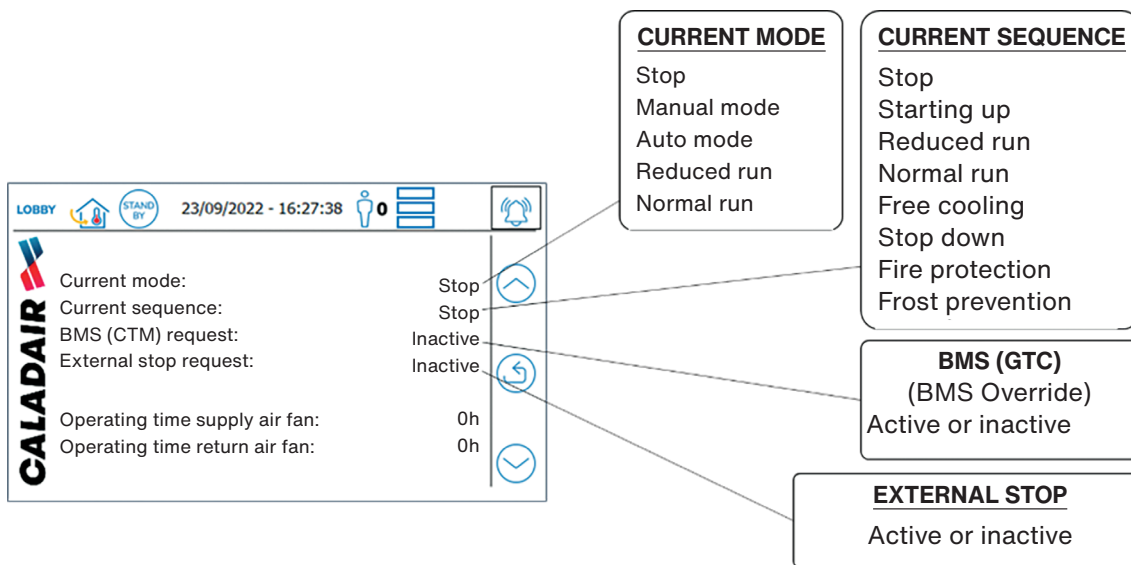





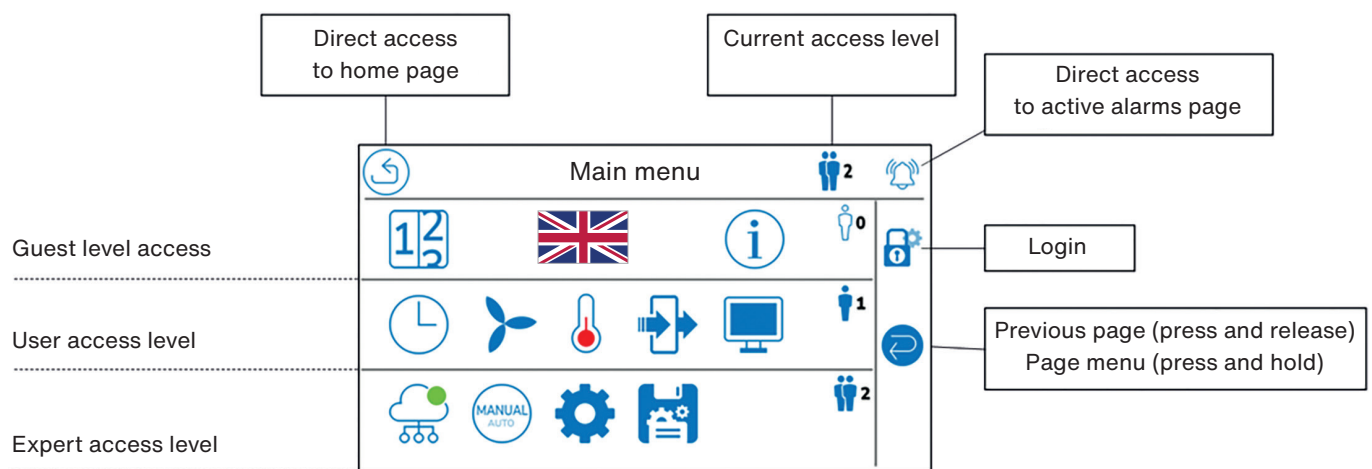



The fan operating time indicates the rate of use of the machine and allows for the adjustment of preventive maintenance intervals in the event that operating time readings are taken. A low utilisation rate allows, for example, inspection tasks to be spread out and a possible next service date to be planned.



35.6. Navigation and menu access

The Main Menu page is accessed from the home page 1 (button).



Symbol	Access to...	Required access level	Details
	General system information	Guest	Firmware version Control programme version Communication errors between display and controller Display status
	Maintenance counter setting	Guest	Alarm maintenance / periodic maintenance
	Active alarms and alarm history menu	Guest	Alarm presence and acknowledgement Recorded alarms
	Setting the clock and time setpoints	Service	System date and time Time periods Holiday calendar
	Fan setpoint configuration	Service	Reduced operation setpoint (LS) Normal operation setpoint (HS) CO ₂ setpoint
	Adjustment of thermal-related setpoints	Service	Temperature control mode Temperature setpoint(s) Temperature limits
	Reading the controller's input/output values	Service	Analogue inputs AI - UAI Digital inputs DI Analogue outputs AO Digital outputs DO
	Setting the Zehnder EDT2 remote room control	Service	Activation / deactivation Restart time Min. temperature offset Max. temperature offset
	Setting the communication parameters (CTM)	Expert	Modbus RTU- Bacnet MS/TP Modbus TCP- Bacnet IP
	Control in manual mode	Expert	Control of outputs in manual mode. Reserved for advanced diagnosis.
	Other settings and configuration	Expert	Sensors Actuators Functions PID Alarms
	Restoring and saving settings	Expert	Restoring and saving user settings. Restoring factory settings.

Notes



Notes

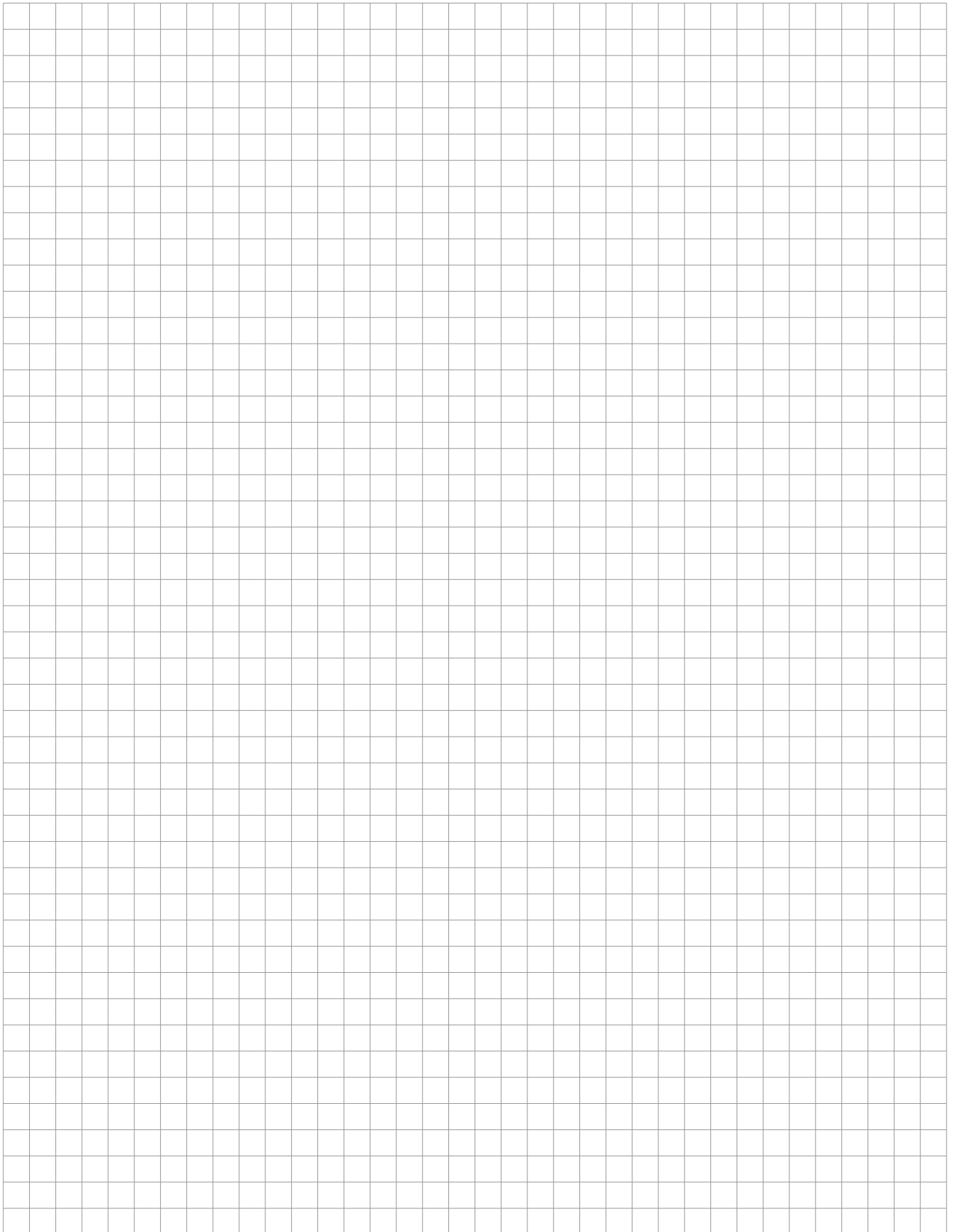

Notes

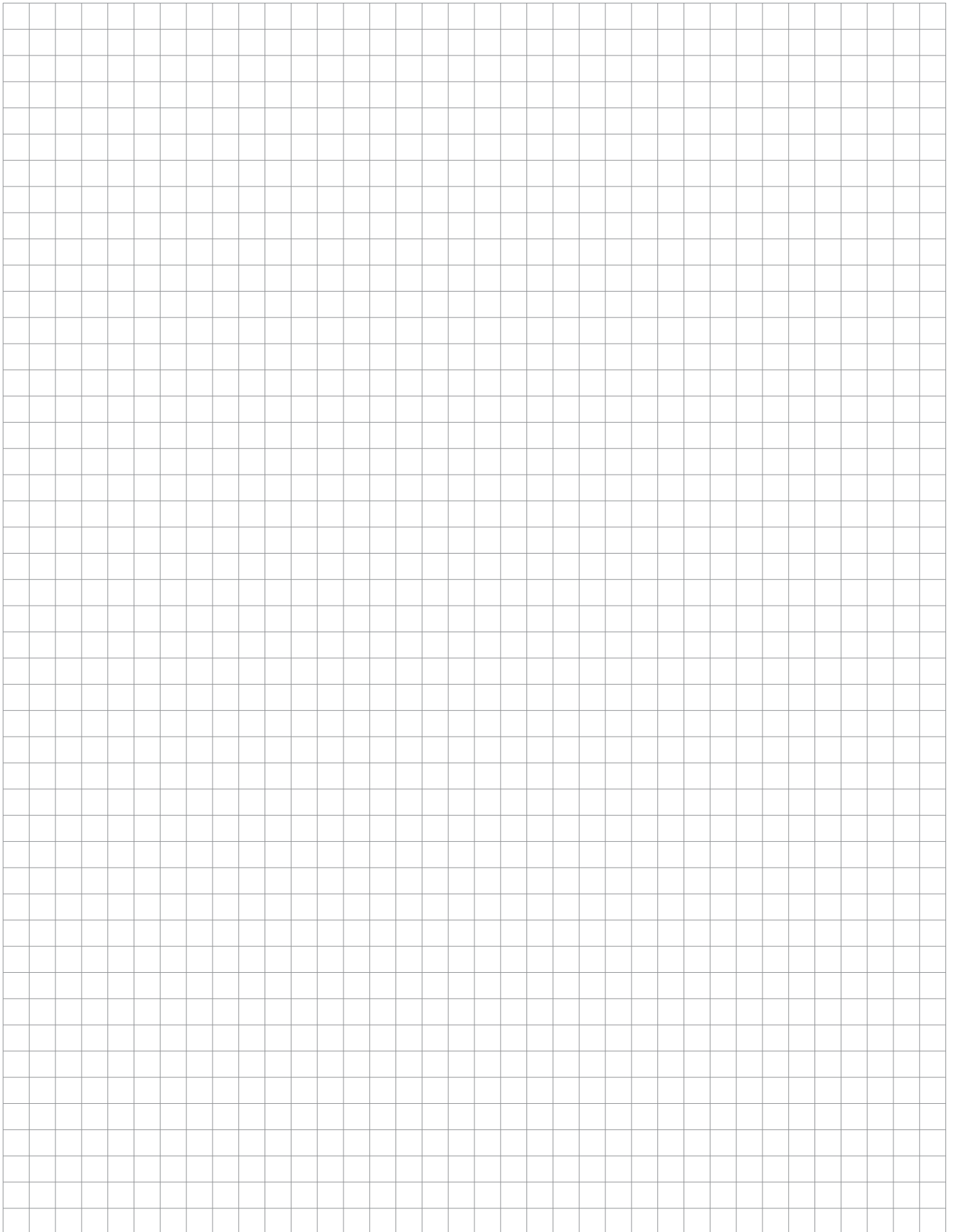

Company

1st line of address ■ Town ■ Country
email ■ website